



### PRODUCT



### DESCRIPTION

- Opening angle: 95°
- Depth of hinge cup: 11.5mm
- Diameter of hinge cup: 35mm
- Range of door thickness: 19-35mm
- Possible drilling distances on the door(K): 3-9 mm

### APPLICATION

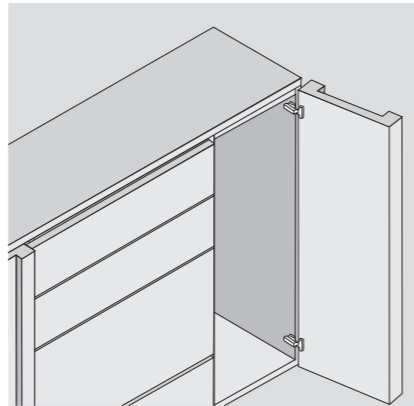

### PLANNING

#### Space needed to open the door

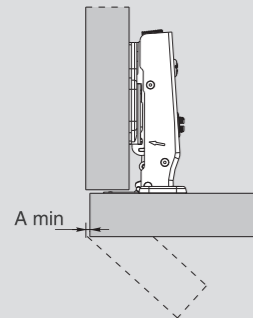

|     | T= | 19  | 20  | 21  | 22  | 23  | 24  | 25  | 26  | 27  | 28  | 29  | 30  | 31  | 32 - 35   |
|-----|----|-----|-----|-----|-----|-----|-----|-----|-----|-----|-----|-----|-----|-----|-----------|
| K=3 | A= | 0.1 | 0.2 | 0.3 | 0.4 | 0.5 | 0.7 | 0.9 | 1.3 | 2.2 | 3.2 | 4.1 | 5.0 | 6.0 | 7.0 - 10  |
| K=4 | A= | 0.1 | 0.2 | 0.3 | 0.4 | 0.5 | 0.7 | 0.8 | 1.0 | 1.6 | 2.5 | 3.5 | 4.4 | 5.3 | 6.3 - 9.1 |
| K=5 | A= | 0.1 | 0.2 | 0.3 | 0.4 | 0.5 | 0.7 | 0.8 | 1.0 | 1.2 | 2.0 | 2.9 | 3.7 | 4.7 | 5.6 - 8.4 |
| K=6 | A= | 0.1 | 0.2 | 0.3 | 0.4 | 0.5 | 0.6 | 0.8 | 1.0 | 1.2 | 1.4 | 2.3 | 3.2 | 4.1 | 5.0 - 7.8 |
| K=7 | A= | 0.1 | 0.2 | 0.3 | 0.4 | 0.5 | 0.6 | 0.8 | 1.0 | 1.2 | 1.4 | 1.8 | 2.7 | 3.6 | 4.4 - 7.0 |
| K=8 | A= | 0.1 | 0.2 | 0.3 | 0.4 | 0.5 | 0.6 | 0.8 | 1.0 | 1.1 | 1.4 | 1.6 | 2.2 | 3.1 | 3.9 - 6.5 |
| K=9 | A= | 0.1 | 0.2 | 0.3 | 0.4 | 0.5 | 0.6 | 0.8 | 0.9 | 1.1 | 1.3 | 1.6 | 1.8 | 2.6 | 3.4 - 6.0 |

#### Space needed to open the door

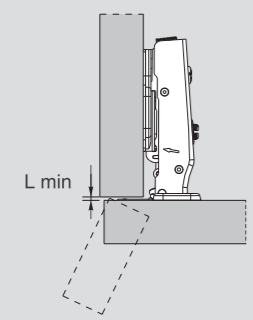

|     | T= | 19  | 20  | 21  | 22  | 23  | 24  | 25  | 26  | 27  | 28  | 29  | 30  | 31  | 32 - 35   |
|-----|----|-----|-----|-----|-----|-----|-----|-----|-----|-----|-----|-----|-----|-----|-----------|
| K=3 | L= | 0.0 | 0.0 | 0.0 | 0.0 | 0.0 | 0.0 | 0.0 | 0.0 | 0.0 | 0.0 | 0.0 | 0.0 | 0.0 | 0.0 - 0.0 |
| K=4 | L= | 0.0 | 0.0 | 0.0 | 0.0 | 0.0 | 0.0 | 0.0 | 0.0 | 0.0 | 0.0 | 0.0 | 0.0 | 0.0 | 0.0 - 0.0 |
| K=5 | L= | 0.0 | 0.0 | 0.0 | 0.0 | 0.0 | 0.0 | 0.0 | 0.0 | 0.0 | 0.2 | 0.2 | 0.3 | 0.4 | 0.5 - 0.7 |
| K=6 | L= | 0.3 | 0.4 | 0.5 | 0.6 | 0.7 | 0.7 | 0.8 | 0.9 | 1.0 | 1.2 | 1.2 | 1.3 | 1.4 | 1.5 - 1.7 |
| K=7 | L= | 1.3 | 1.4 | 1.5 | 1.6 | 1.7 | 1.7 | 1.8 | 1.9 | 2.0 | 2.2 | 2.2 | 2.3 | 2.4 | 2.5 - 2.7 |
| K=8 | L= | 2.3 | 2.4 | 2.5 | 2.6 | 2.7 | 2.7 | 2.8 | 2.9 | 3.0 | 3.2 | 3.2 | 3.3 | 3.4 | 3.5 - 3.7 |
| K=9 | L= | 3.3 | 3.4 | 3.5 | 3.6 | 3.7 | 3.7 | 3.8 | 3.9 | 4.0 | 4.2 | 4.2 | 4.3 | 4.4 | 4.5 - 4.7 |

- The above values are calculated on the assumption that the doors have square edges.
- They are reduced if the doors have radiussed edges.

#### Projection of the door

Projection of the door from the cabinet side at the max opening. The figures are based on a straight arm hinge, H=0mm mounting plate and drilling distance (K) =3mm.

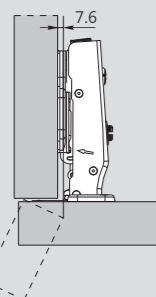

#### "C" value

$$C=22+K+A$$

With this formula you can obtain the max. thickness of the moulded door that can be opened without touching adjacent carcass sides, doors or walls, whilst bearing in mind the above L-K-T values.

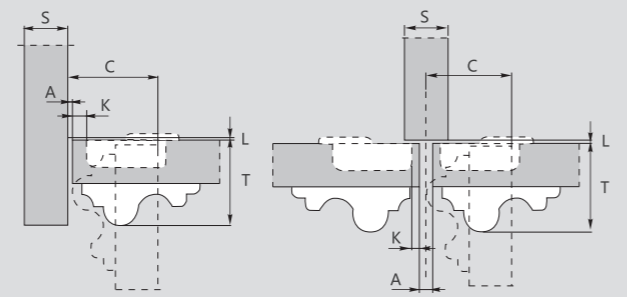

### ORDER INFORMATION



#### $\Phi$ 35mm Options of screws and dowels:

|                                  |   |
|----------------------------------|---|
| M10 dowel<br>Dowel No: <b>M</b>  | Expandable dowel<br>Dowel No: <b>K</b>  |
| M8 dowel<br>Dowel No: <b>N</b>   | Expandable dowel<br>Dowel No: <b>K0</b> |
| Euro screw<br>Dowel No: <b>B</b> | Quick dowel<br>Dowel No: <b>T0</b>      |

#### $\Phi$ 35mm Hinge cup types

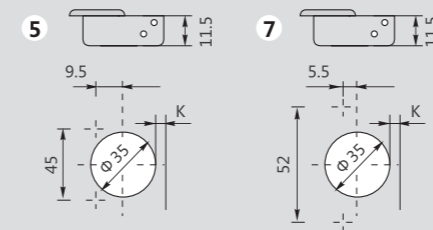

Use these formulas to determine the type of hinge arm, the drilling distance "K" and the height of the mounting plate "H" for each door application.

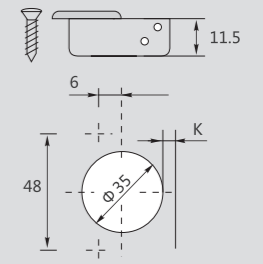

Nickel plated(A01)

#### C80 series snap-on soft close hinge 95° (two way, cam-adjustable)

##### Full overlay C=0



$$H=12+K-(D)$$

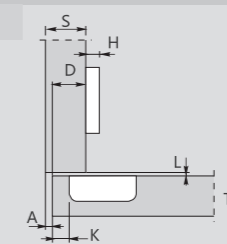

|            | Item No.        | Pcs/ctn |
|------------|-----------------|---------|
| Soft-close | <b>C80A616F</b> | 200     |
| Sprung     | <b>C80A616</b>  | 200     |

##### Half overlay C=9

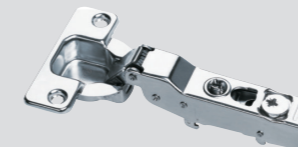

$$H=3+K-(D)$$

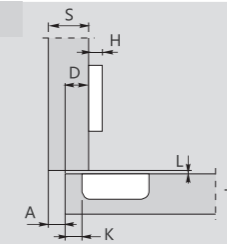

|            | Item No.        | Pcs/ctn |
|------------|-----------------|---------|
| Soft-close | <b>C80B616F</b> | 200     |
| Sprung     | <b>C80B616</b>  | 200     |

##### Inset C=18

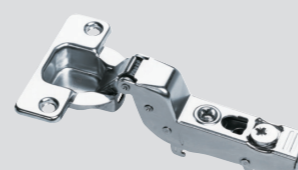

$$H=-6+K+(A)$$

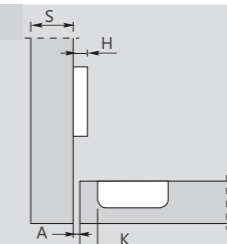

|            | Item No.        | Pcs/ctn |
|------------|-----------------|---------|
| Soft-close | <b>C80C616F</b> | 200     |
| Sprung     | <b>C80C616</b>  | 200     |