



FABULIS[®]
O ACESSÓRIO ESSENCIAL

INDÍCE

- A. Corrediças de Gaveta
Drawer Slide
- B. Gavetas de Cozinha
Kitchen Drawer
- C. Gavetas Magic Pro
Magic Pro Drawer
- D. Corrediças de Mesa
Table Slides
- E. Dobradiças
Hinges
- F. Acessórios de Cozinha
Kitchen Accessories
- G. Perfis de Alumínio
Aluminium Profiles
- H. Iluminação
Lighting
- I. Sistemas de Roupeiro
Wardrobe Systems
- J. Pés e Rodízios
Legs and Castors
- K. Sistemas de Ligação
Connection Systems
- L. Compassos
Lifting Systems
- M. Suportes de Prateleira
Shelf Support
- N. Fechos e Fechaduras
Latches and Locks
- O. Asas e Puxadores
Handles and Knobs
- P. Diversos
Others



A

Corrediças de Gaveta
Drawer Slide



Corrediça DTC C/Amort. Ext. Parcial
DTC Soft Close Partial Extension Slide

A22

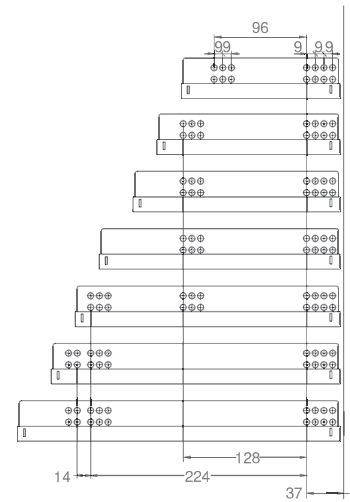
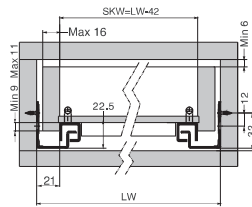

	250	300	350	400	450	500	550
	10	10	10	10	10	10	10

Corrediça DTC Oculta
DTC Invisible Slide

N11

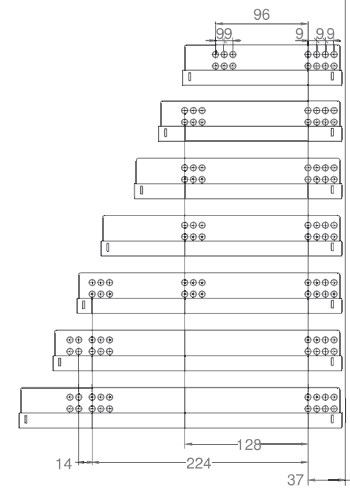
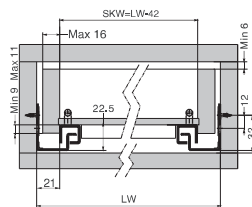

	250	300	350	400	450	500	550
	10	10	10	10	10	10	10

Corrediça DTC Tic-Tac Ext. Parcial
DTC Push to Open Partial Extension slide

N33

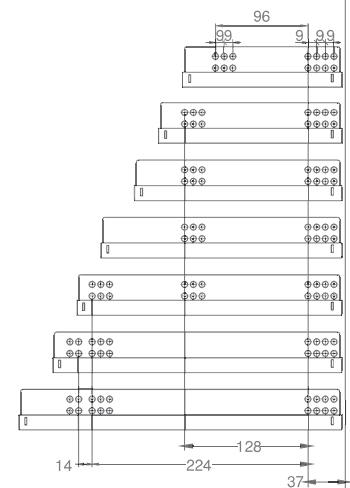
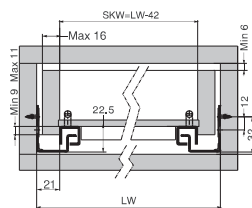

	250	300	350	400	450	500	550
	10	10	10	10	10	10	10

Corrediça DTC C/Amort. Ext. Total c/Patilha
DTC Soft Close Full Extension Slide w/Clip

A

M43

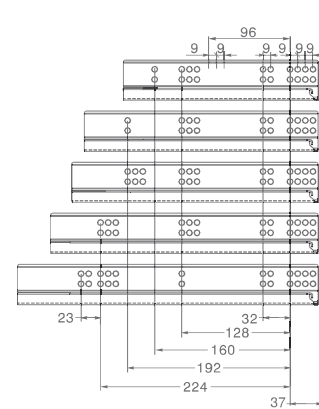
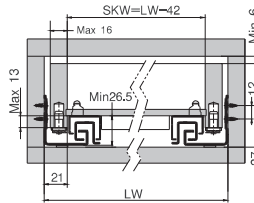
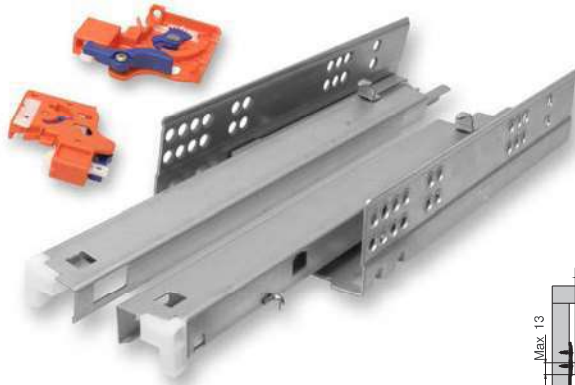

	300	350	400	450	500
	10	10	10	10	10

Corrediça DTC C/Amort. Ext. Total
DTC Soft Close Full Extension Slide

N83

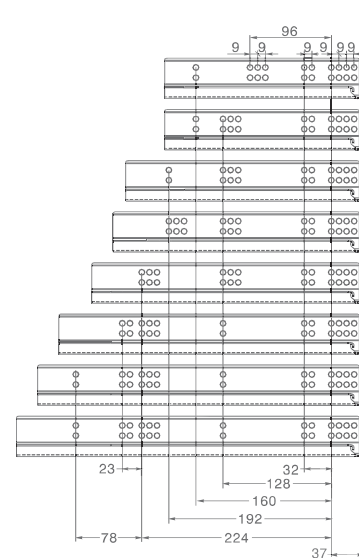
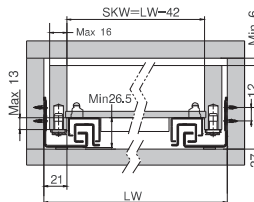
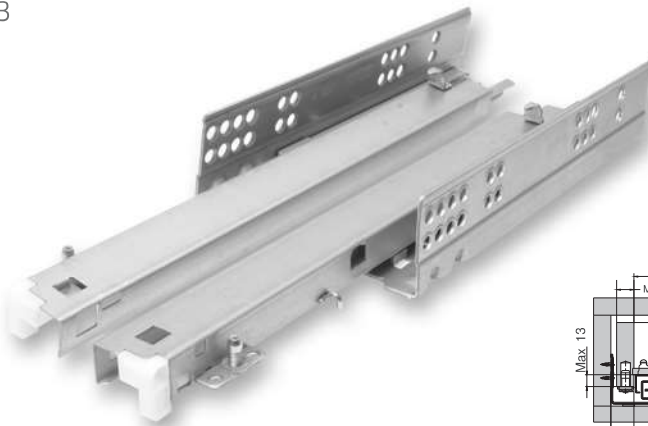

	250	300	350	400	450	500	550	600
	10	10	10	10	10	10	10	10

Corrediça DTC Tic-Tac Ext. Total
DTC Push to Open Full Extension Slide

Q52

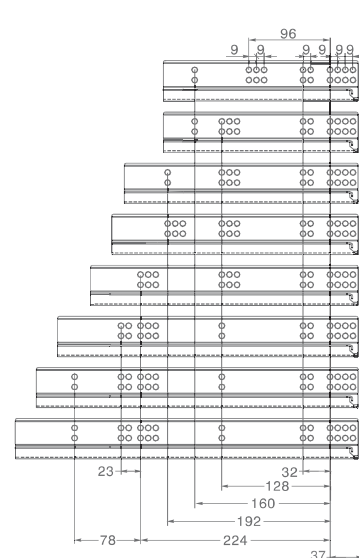
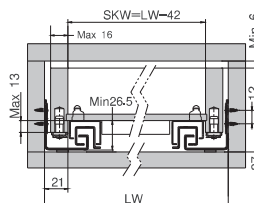
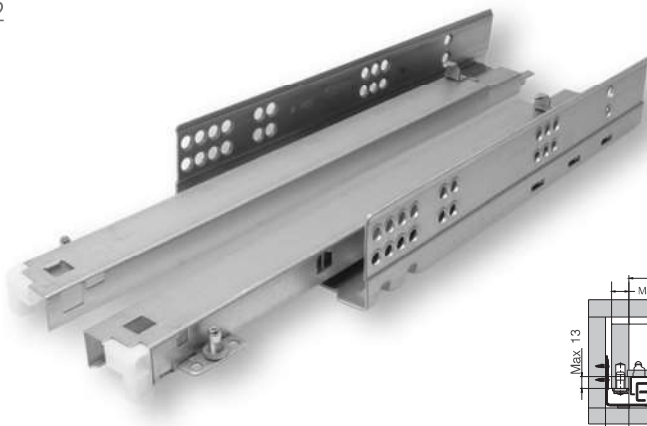

	250	300	350	400	450	500	550	600
	10	10	10	10	10	10	10	10

Corrediça DTC Ext. Total C/Amort. + Afin. 3D
DTC Soft Close Full Extension Slide + 3D Adjust.

R57

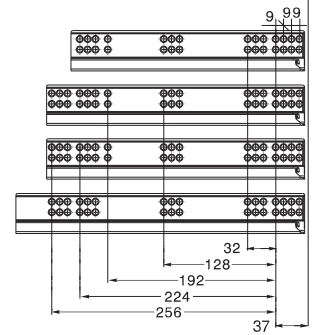
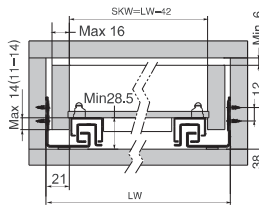

	350	400	450	500
	6	6	6	6

Corrediça DTC Ext. Total Tic-Tac Sinc.
DTC Synchronized Push to Open Full Ext. Slide

R58

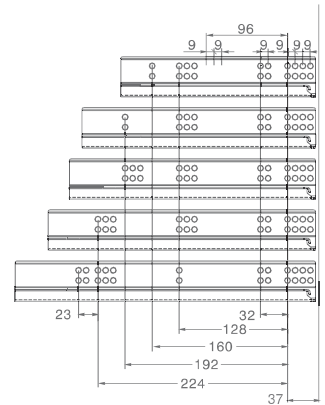
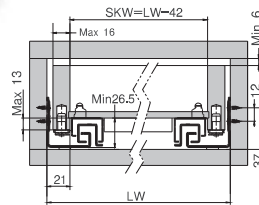

	300	350	400	450	500
	6	6	6	6	6

Corrediça Roletos de Nylon Cinza
Nylon Wheels Grey Slide

087

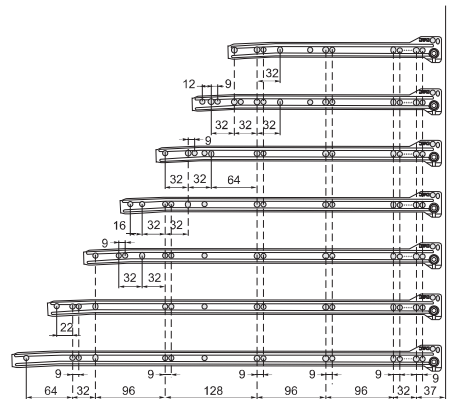
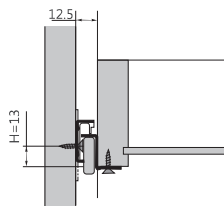

	250	300	350	400	450	500	550	600
	20	20	20	20	20	20	20	20
	25	25	25	25	25	25	25	25

Corrediça Telescópica Ext. Total
Full Extension Telescopic Slide

Q59

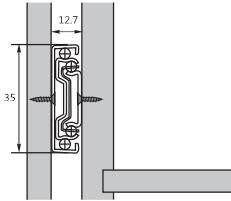
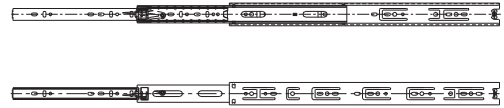

↔	250	300	350	400	450	500	550	600
📦	20	20	20	20	20	20	20	20

Corrediça Telescópica Ext. Total
Full Extension Telescopic Slide

C86

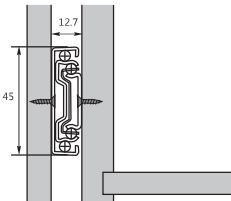
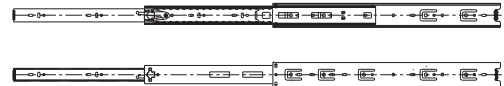

↔	250	300	350	400	450	500	550	600	650	700
📦	15	15	15	15	15	15	15	15	15	15

Corrediças c/Laterais de Metal DTC
DTC Metal Side Panel Slides

Amortecedor p/ Corred. c/ Lat. de Metal DTC
DTC Metal Side Panel Slides Soft-Close Device

686



↕	↔	📦	Cores: Colors:
86	350	10	●
86	400	10	●
86	450	10	●
86	500	10	●
118	500	10	●
150	500	10	●

P24



📦	200
---	-----

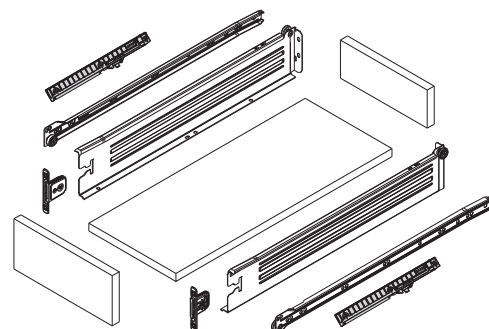
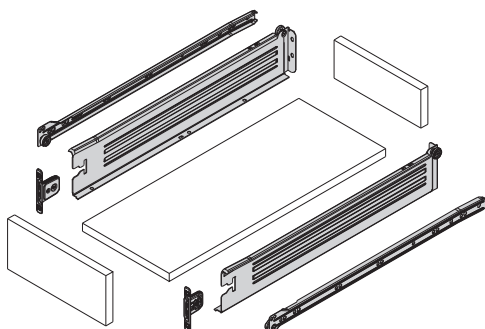

Vara para Sincronizar Corrediça Tic-Tac
Rod for Push to Open Synchronization

R59.CRD

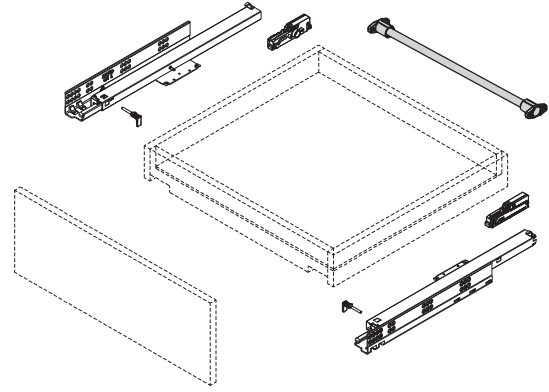
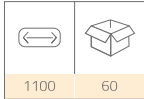

Adap. de Vara para Sincronizar Corrediça Tic-Tac
Adapter to Rod for Push to Open Synchronization

R60.CRD

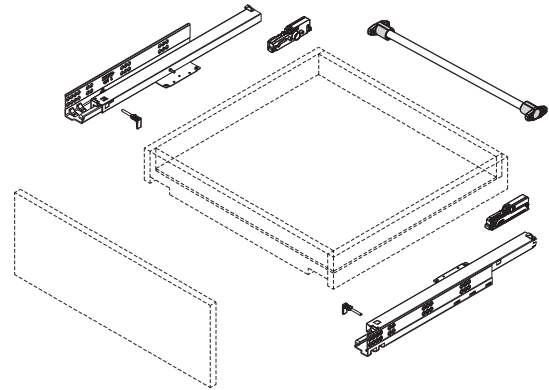

Pin de Fixação p/ Corrediça de Ext. Total
Full Extension Slide Fixing Pin

P64.01

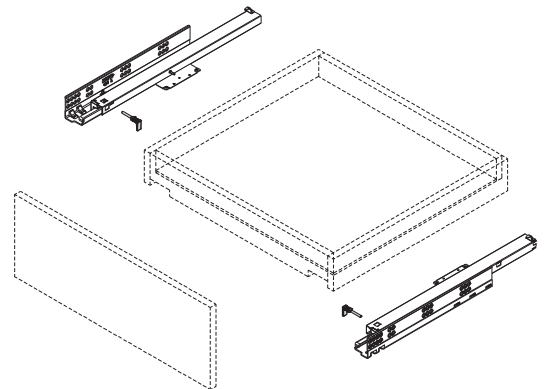
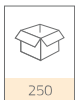

Pin de Fixação p/ Corrediça de Ext. Parcial
Partial Extension Slide Fixing Pin

P64.02

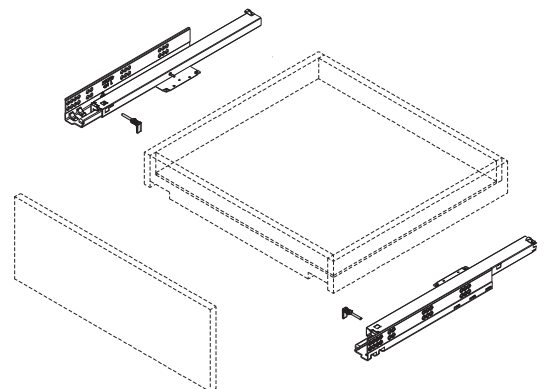

B

Gavetas de Cozinha
Kitchen Drawers



Gaveta Extração Total DTC
DTC Full Ext. Double-Wall Drawer

044

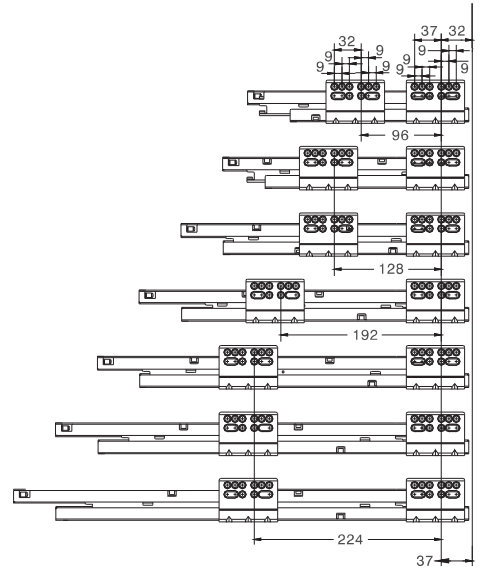

	270	300	350	400	450	500	550	600	650
	1	1	1	1	1	1	1	1	1
Cores: Colors:	●	○	●	○	●	○	●	○	●

50
RG

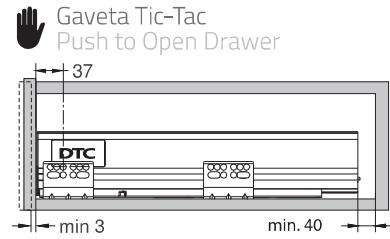
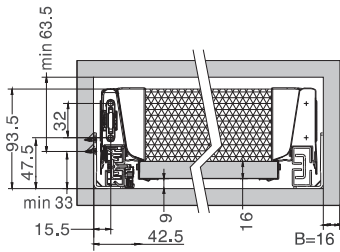

Vareta Redonda DTC
DTC Round Side Rail

007.RED



←	⊞
270	60
300	60
350	60
400	60
450	60
500	60
550	60
600	60
650	60
1100	60

Cores:
Colors:

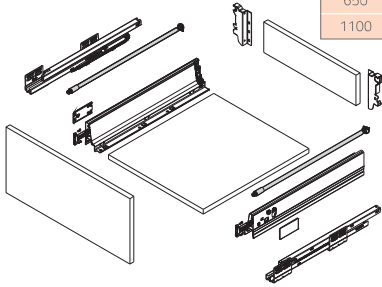

Vareta Quadrada DTC
DTC Square Side Rail

007.QD



←	⊞
300	60
350	60
400	60
450	60
500	60
1100	60

Cores:
Colors:

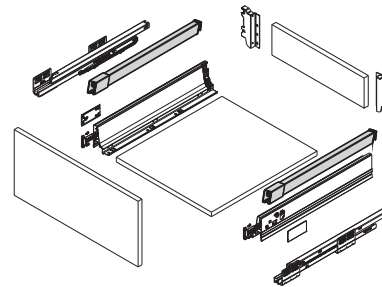

Traseiro Para Gaveta DTC
DTC Back Fixing Brackets

059



↑	⊞
125	40
190	20

Cores:
Colors:

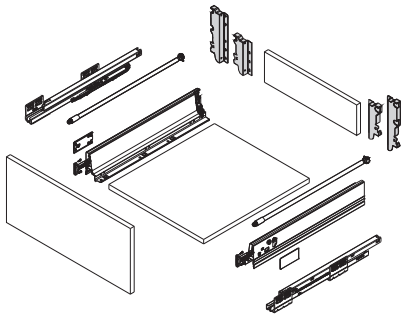

Traseiro Alto de 1 Vareta DTC
DTC Back Fixing Bracket to 1 Side Rail

Q58



↑	⊞
190	20

Cores:
Colors:

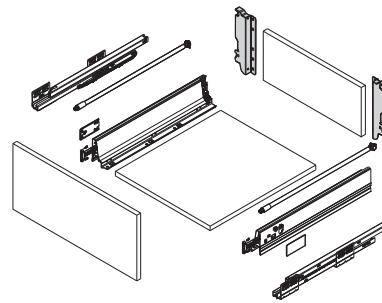

Fix. Traseiro p/ Vareta DTC
DTC Side Rail Back Fixing Bracket

R56



⊞
200

Cores:
Colors:

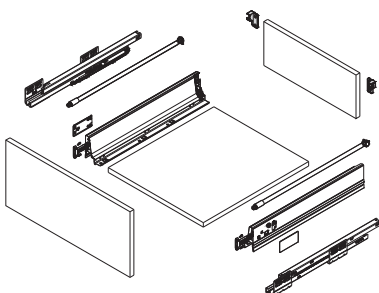

Fixador Frontal p/Vareta Quadrada DTC
DTC Front Fixing Brackets to Square Rails

056.QD



↑	⊞
95	60
153	40
218	20

Cores:
Colors:

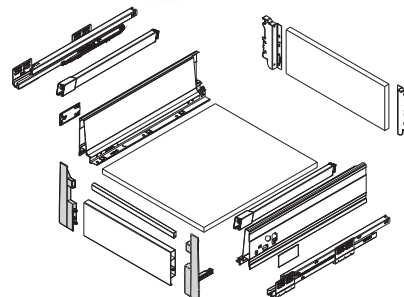

Fixador Frontal p/ Vareta Redonda DTC
DTC Front Fixing Brackets to Round Rails

O56.RED



95	60
153	40
218	20

Cores:
Colors:

● ○
● ○
● ○

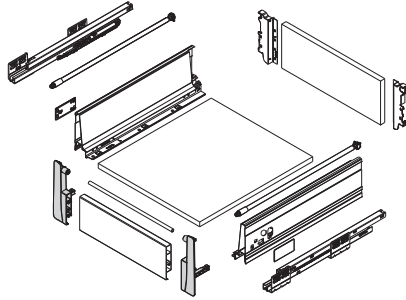

Perfil Frontal DTC
DTC Front Section

O57



1100	20

Cores:
Colors:

● ○

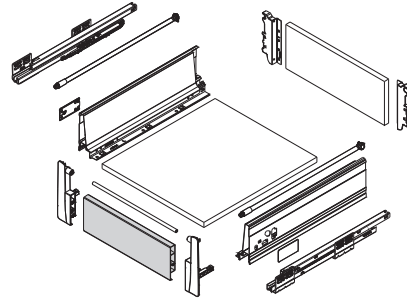

Painel Lateral Perfurado DTC
DTC Metal Box-Side

O24



500	20

Cores:
Colors:

●

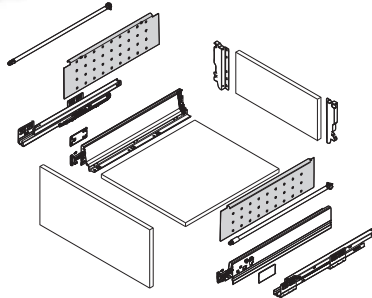

União Vareta Transv. a Vareta Lat. DTC
Single DTC Cross Rail Connector to Metal Box-side

P80



200

Cores:
Colors:

●

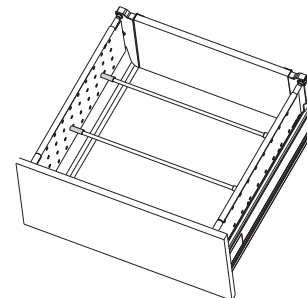

Fix. Divisória Transv. p/Painel Perf. DTC
DTC Cross Divider Connector

P74



60

Cores:
Colors:

●

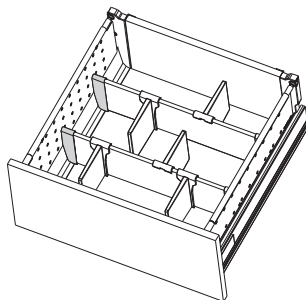

Fix. Div. Transversal p/Vareta DTC
DTC Cross Divider Connector

P73



60

Cores:
Colors:

●

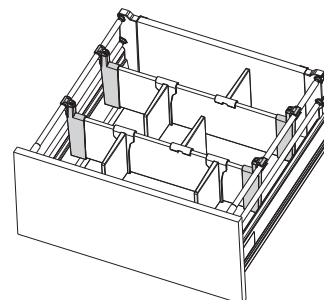

Separador Div. Transversal DTC
DTC Drawer Divider

P72

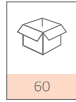

Cores:
Colors:

60

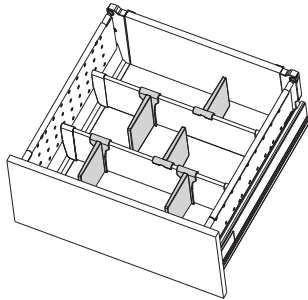

União Var. Transv. a Vareta Lat. DTC
DTC Single Cross Rail Connector

P76



Cores:
Colors:

640

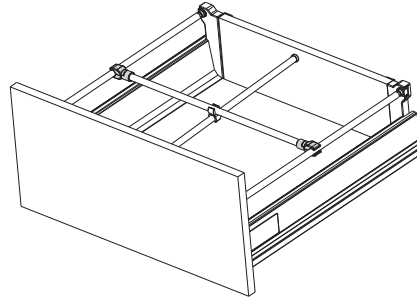

Divisória Dupla Transversal DTC
DTC Double Cross Rail Connector

P78

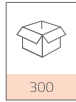

Cores:
Colors:

300

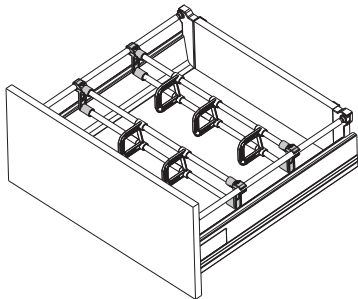

Divisória Transversal DTC
DTC Cross Divider

P75

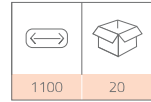

1100

20

Cores:
Colors:

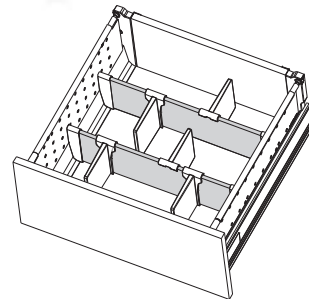

Sep. de Vareta p/Div. Dupla Transv. DTC
DTC Divider on Double Cross Rail

P79



Cores:
Colors:

300

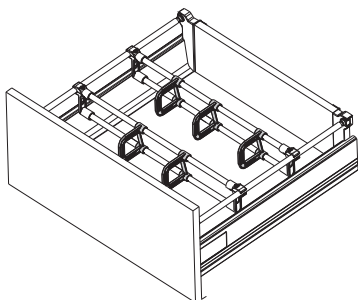

Fixador Frontal p/Gav. de Canto DTC
DTC Front Fixing Bracket

060

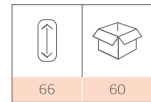

66

60

Cores:
Colors:

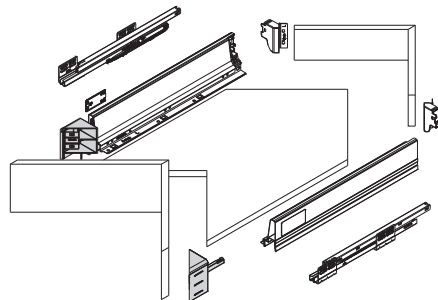

Fixador Traseiro p/Gav. Canto DTC
DTC Corner Back Fixing Bracket

061

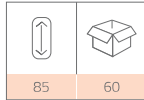

Cores:
Colors: ● ○

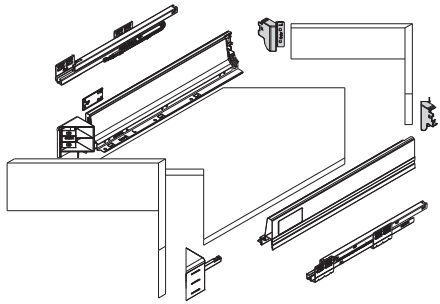

Sifão Fino
Slim U-Shaped Piece

063.FN



Cores:
Colors: ● ○

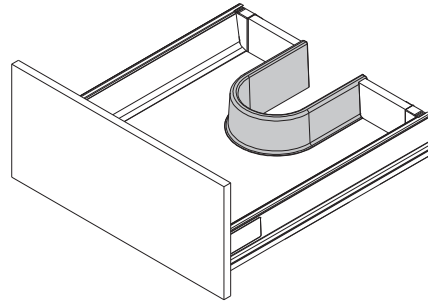

Sifão DTC
DTC U-Shaped Piece

063



Cores:
Colors: ● ○

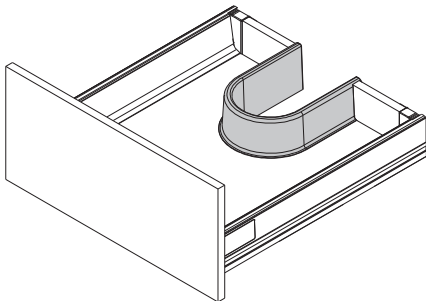

Estabilizador p/Gaveta DTC
DTC Drawer Stabilizer

R55



Cores:
Colors: ● ○

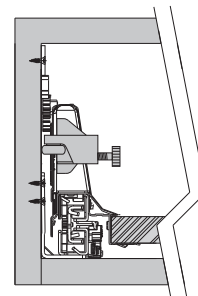

Puxador p/Gaveta Int. DTC
DTC Drawer Handle

062



Cores:
Colors: ● ○

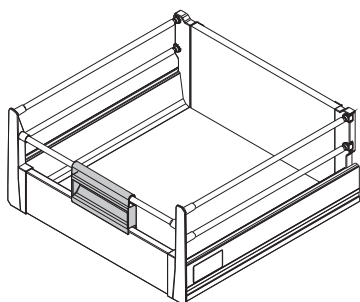

Distanciador de Gaveta DTC
DTC Drawer Spacer

Q31



Cores:
Colors: ● ○

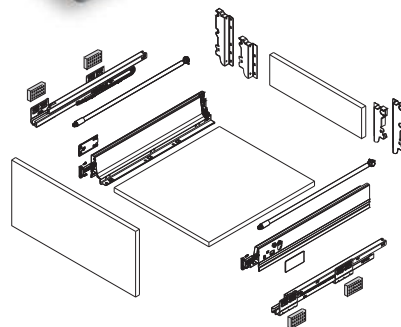

Acess. p/ Lateral de Acrílico DTC
DTC Acrylic Side Accessories

Q45 Sup. Front./ Tras. p/Acrílico Médio DTC
DTC Acrylic Front/ Rear Support

①

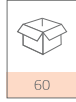

Cores:
Colors:

Q94 Lateral de Apoio em Acrílico DTC
DTC Acrylic Side Support

②



Q46 Redução de Vidro P/ Acrílico Médio DTC
DTC Glass Reduction

③



Cores:
Colors:

Q56 Sup. Front./ Tras. p/Acrílico Alto DTC
DTC Acrylic Front/ Rear Support

④

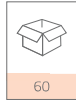

Cores:
Colors:

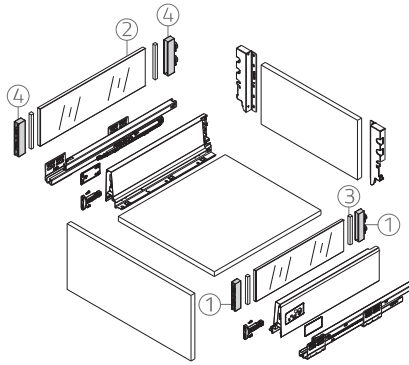

Q57 Redução de Vidro P/ Acrílico Alto DTC
DTC Glass Reduction

⑤

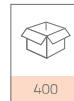

Cores:
Colors:

R46 Sup. Front. p/Acrílico Alto DTC p/Vareta Quadrada
DTC Acrylic High Front Support for Square Rails



Cores:
Colors:



R46 Sup. Front. p/Acrílico Tras. DTC p/Vareta Quadrada
DTC Acrylic High Rear Support for Square Rails

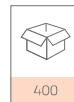

Cores:
Colors:

Vara para Sincronizar Gaveta Tic-Tac
Rod for Push to Open Drawer Synchronization

R59.GAV

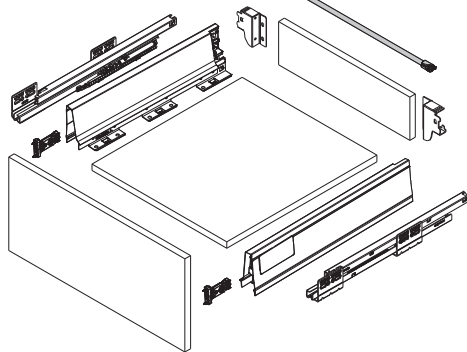
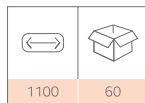

Adapt. de Vara para Sincronizar Gaveta Tic-Tac
Adapter to Rod for Push to Open Drawer Synchronization

R60.GAV

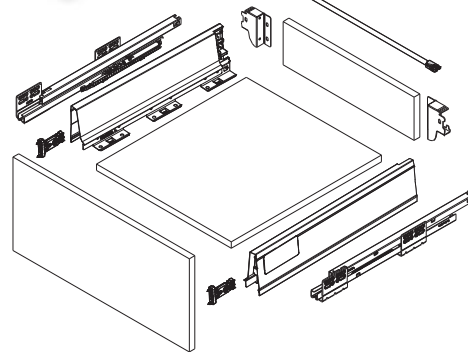

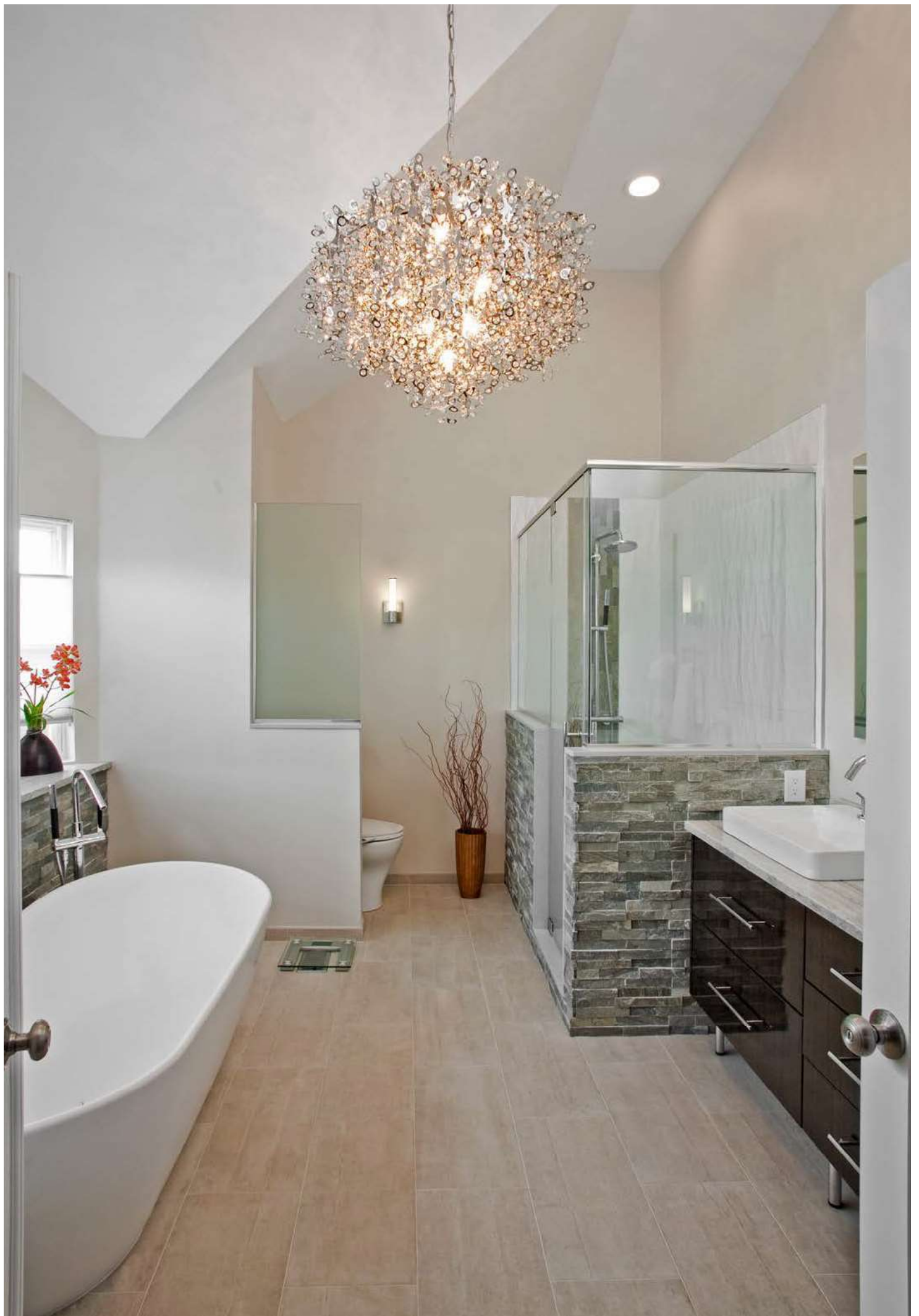



Gavetas Magic Pro
Magic Pro Drawers



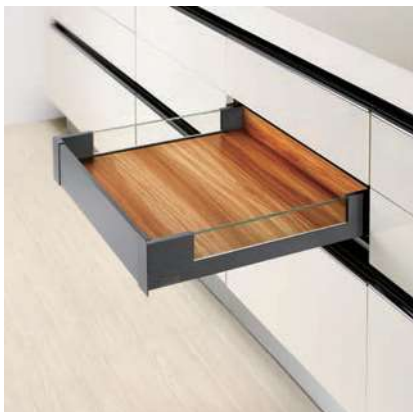

R74



Gaveta Magic Pro 88 MM DTC
DTC 88 MM Magic Pro Drawer

	Cores:
350	● ○
400	● ○
450	● ○
500	● ○

S82 Correção Tic-Tac
Push to Open Slide

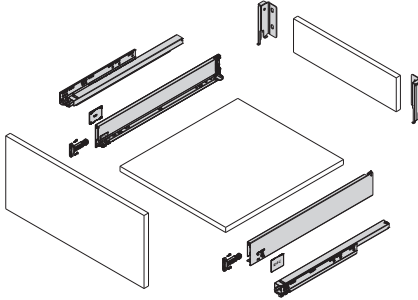

R75



Gaveta Magic Pro 126 MM DTC
DTC 126 MM Magic Pro Drawer

	Cores:
350	● ○
400	● ○
450	● ○
500	● ○

S82 Correção Tic-Tac
Push to Open Slide

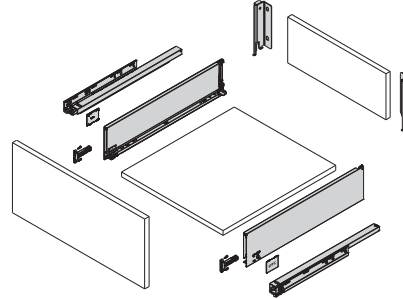

R76



Gaveta Magic Pro 172 MM DTC
DTC 172 MM Magic Pro Drawer

	Cores:
350	● ○
400	● ○
450	● ○
500	● ○

S82 Correção Tic-Tac
Push to Open Slide

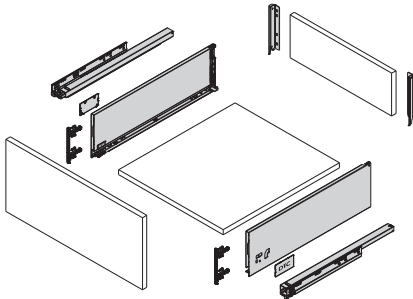

R80



Gaveta Magic Pro 238 MM DTC
DTC 238 MM Magic Pro Drawer

	Cores:
500	● ○

S82 Correção Tic-Tac
Push to Open Slide

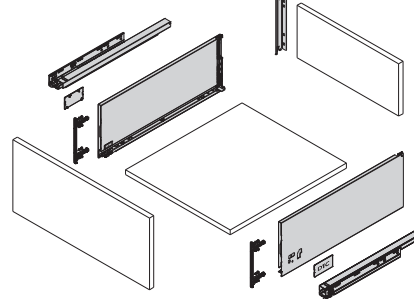

S23



Gaveta Magic Pro 88 MM DTC c/Lateral de Vidro
DTC 88 MM Magic Pro Drawer w/Glass Lateral

	Cores:
500	● ○

S82 Correção Tic-Tac
Push to Open Slide

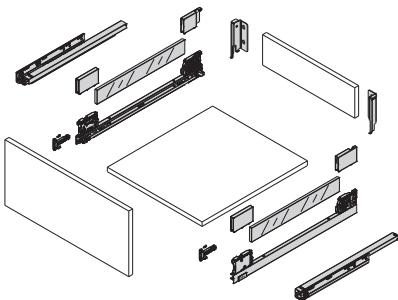

S24



Gaveta Magic Pro 172 MM DTC c/Lateral de Vidro
DTC 172 MM Magic Pro Drawer w/Glass Lateral

	Cores:
500	● ○

S82 Correção Tic-Tac
Push to Open Slide

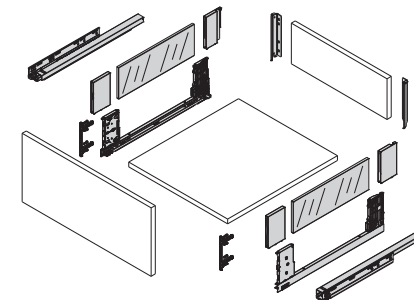

Vareta Quadrada Magic Pro DTC
DTC Magic Pro Square Side Rail

007.MP



		Cores: Colors:
350	60	● ○
400	60	● ○
450	60	● ○
500	60	● ○

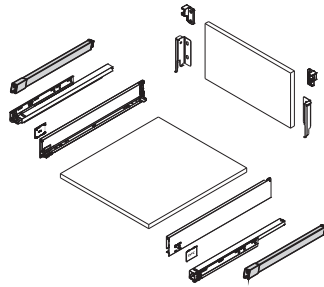

Traseiro para Vareta Magic Pro DTC
DTC Magic Pro Back Fixing Bracket

R56



		Cores: Colors:
50	60	● ○

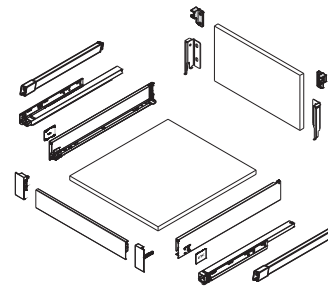

Adap. Frontal Baixo p/ Gav. Magic Pro 88 MM DTC
DTC 88 MM Magic Pro Drawer Small Front Fixing-Bracket

R81



		Cores: Colors:
98	60	● ○

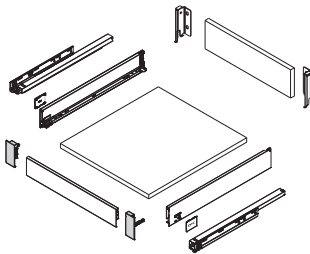

Adap. Frontal Alto p/ Gav. Magic Pro 172 MM DTC
DTC 172 MM Magic Pro Drawer High Front Fixing-Bracket

R82



		Cores: Colors:
185	60	● ○

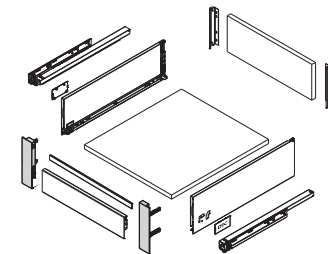

Perfil Frontal p/ Gaveta Magic Pro DTC
DTC Magic Pro Drawer Front Section

R83



		Cores: Colors:
1100	20	● ○

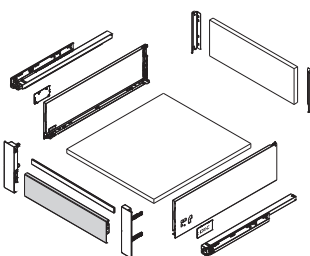

Vareta Frontal p/ Gaveta Magic Pro DTC
DTC Magic Pro Drawer Cross Square Rail

R84



		Cores: Colors:
1100	60	● ○

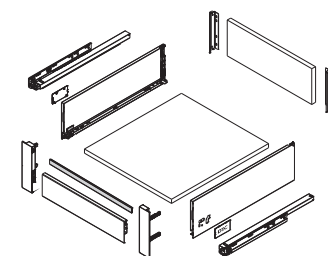

Fixador Frontal p/ Gaveta Int. de Vidro
Interior Glass Drawer Front Fixer

Barra Fronta p/ Gaveta Int. de Vidro
Interior Glass Drawer Front Section

S21

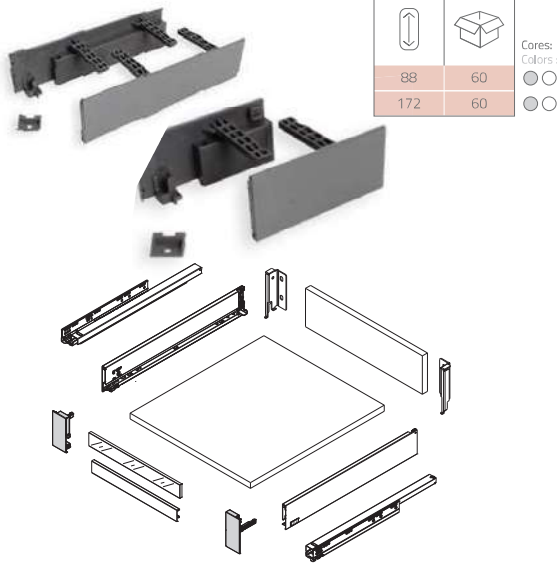

S22

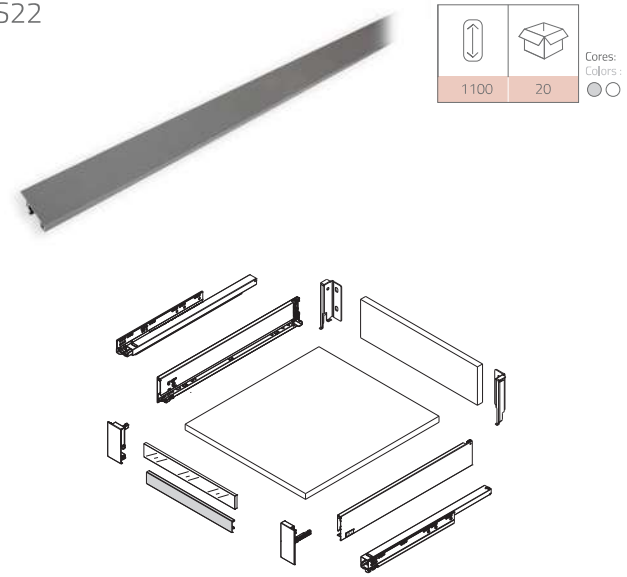



D

Corrediças de Mesa
Table Slides



Corrediça de Mesa Pottker
Pottker Table Slide

L56 / M51

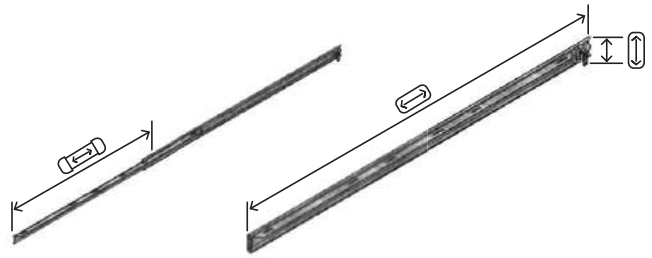

1M5104102XX	1000	580	50	90 kg
1M510410213	1300	885	50	90 kg
1M510410215	1500	1020	50	90 kg
1L5604102X5	1000	630	75	115 kg
1L5604102X6	1300	850	75	115 kg
1L5604102X4	1500	1085	75	115 kg
1L5604102X2	1800	1295	75	115 kg

Corrediça de Mesa Pottker
Pottker Table Slide

P54

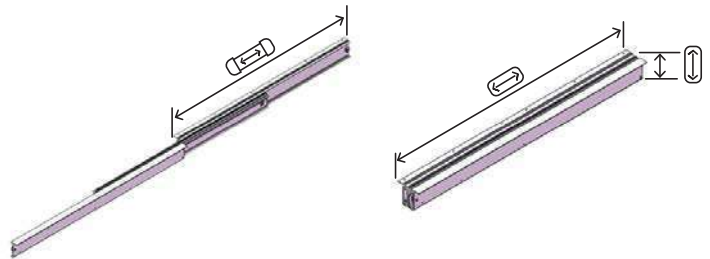

1P5403XXX1	1070	1200	75	115 kg

Corrediça de Mesa Dupla Pottker
Pottker Double Table Slide

S01

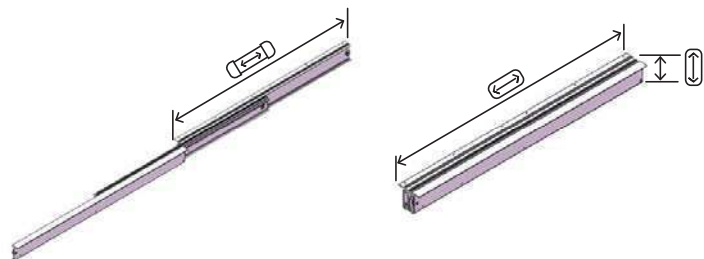

15010410210	1000	1080	75	115 kg
15010410215	1500	1500	75	115 kg

Corrediça de Mesa Pottker
Pottker Table Slide

R53

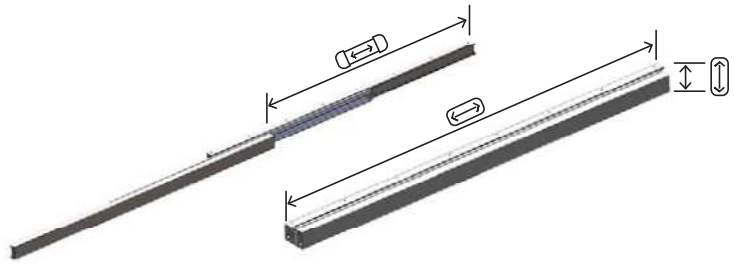

1R5303XXX18	1800	2x500	56	90 kg

Corrediça de Mesa Pottker
Pottker Table Slide

L36

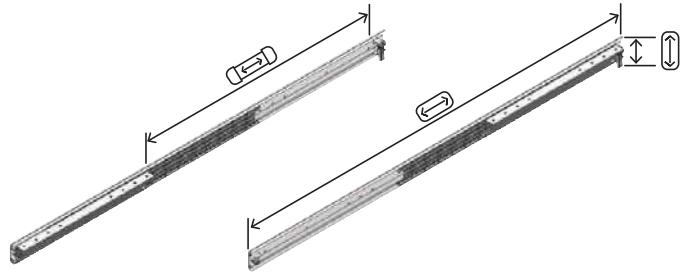

1L3611004-35	1100	650	50	90 kg
1L3613004-35	1300	750	50	90 kg

Corrediça de Mesa Pottker
Pottker Table Slide

M55

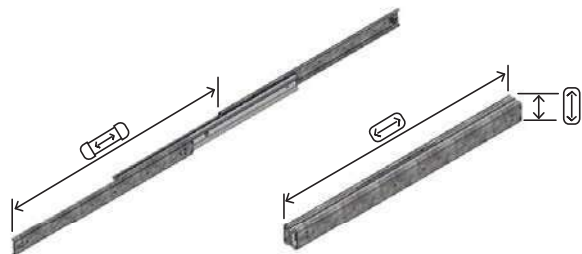

1M5504102TL	610	730	49	90 kg

Corrediça de Mesa Pottker
Pottker Table Slide

M18 / G35 / N46

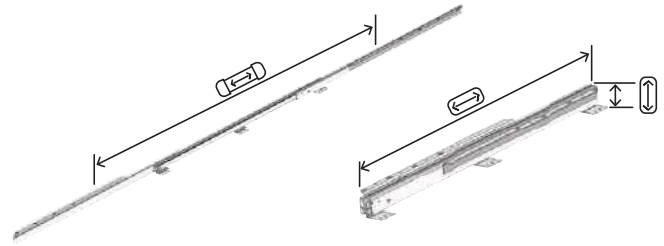

	←→	↔	↑↓	⌞
1M1810102XX	720	2x500	52-96	70 kg
1G35XXXXX72	720	2x500	58-102	90 kg
1G35XXXXX98	980	3x500	58-102	90 kg
1G35XXXXX12	1200	4x450	58-102	90 kg
1N4604102K7	1200	4x500	82-114	115 kg
1N460410215	1500	5x500	82-114	115 kg

Corrediça de Mesa Pottker
Pottker Table Slide

M75 / M41

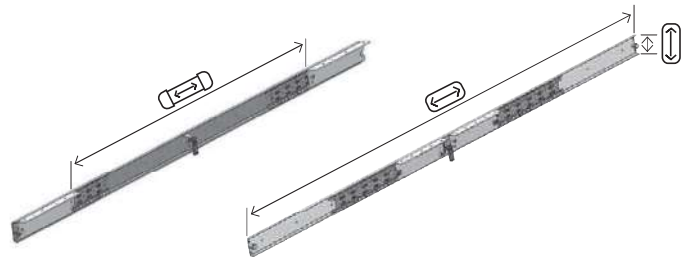

	←→	↔	↑↓	⌞
1M411046260	600	400	39	60 kg
1M411046575	750	500	39	60 kg
1M758504-15	850	500	49	90 kg
1M759504-15	950	650	49	90 kg
1M751150-15	1150	2x400	49	90 kg
1M751250-15	1250	2x450	49	90 kg
1M751350-15	1350	2x500	49	90 kg

Corrediça de Mesa Pottker
Pottker Table Slide

P04

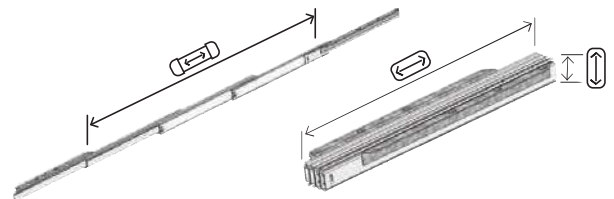

	←→	↔	↑↓	⌞
1P0404102300	300	2100	40	60 kg

Corrediça de Mesa
Table Slide

L15

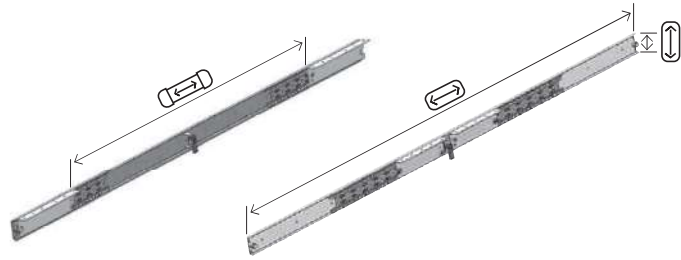

	↔	↔	↑
1L150410270	700	490	35
1L150410275	750	540	35

Corrediça de Mesa
Table Slide

N54

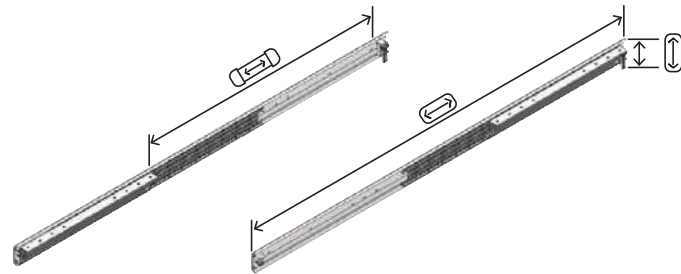

	↔	↔	↑
1N540410260	600	350	35
1N540410211	1100	760	35

Mecanismo de Rotação de Livro
Folding Mechanism

P55

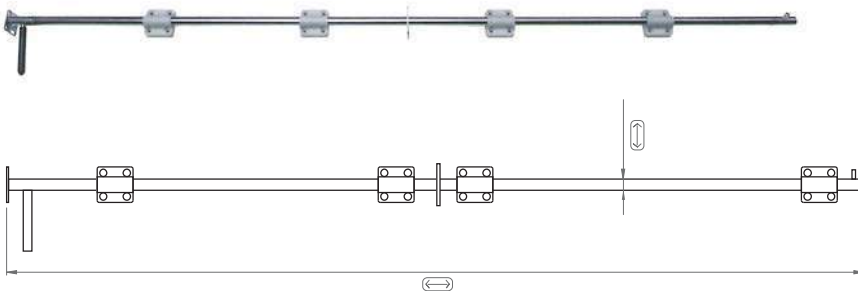

↑	↔
16	1200

Sistema de Livro Flat
Folding Flat System

Q28

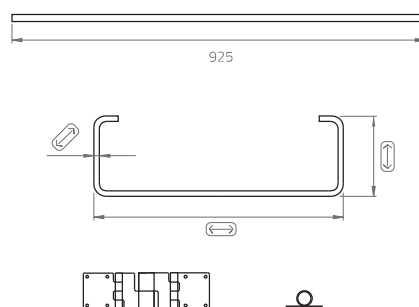

↑	↔	↗
180	560	12



Mecanismo SH p/Mesa Extensível
Extensible Table SH Mechanism

M83

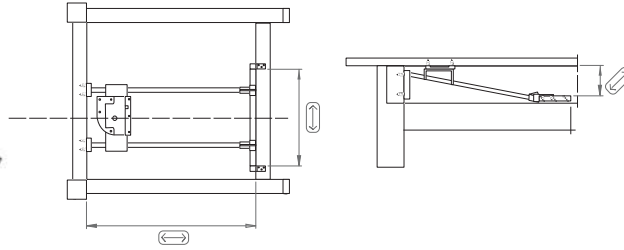

270	492	80

Barra Estabilizadora
Stabiliser Bar

S65

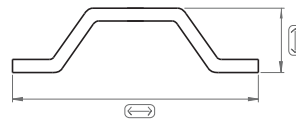

16	60	800
16	60	1000



Chapa em Cunha p/Pino de Tubo/Travão
Wedge Plate for Tube Pin/Brake

R67

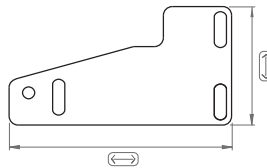

40	75

Braçadeiras Plásticas Pottker
Pottker Plastic Clamps

Q66

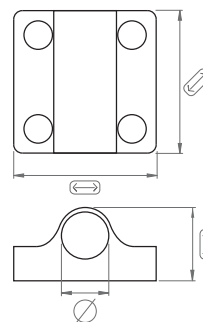

16	26	50	50

Braçadeira para Varão de Sistema Rotativo
Rotative System Rod Clamp

M59

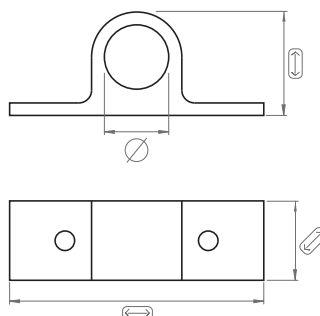

9	18	64	20
16	26	64	20

Tubo P/ Sistema de Mesa Rotativo
Rotative System Rod

N03

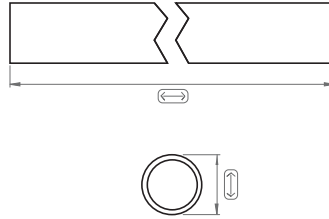

9	900
16	900

Deslizador p/ Aba de Mesa
Table Flap Slider

S05

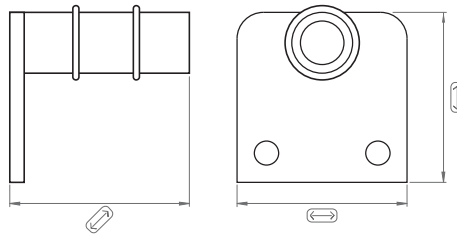

35	35	37

Porca Sextavada
Zinc Nuts

333

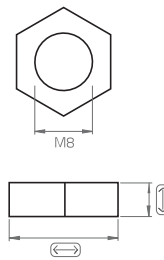

6.2	12.8

Porca de Orelhas
Wing Nuts

799

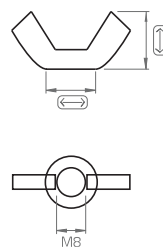

6.2	12.8

Haste 2 Roscas
2 Thread Rod

731

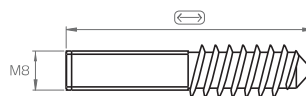

50
70

D

Engate Angular Pé de Mesa
Table Leg Angular Hitch

164

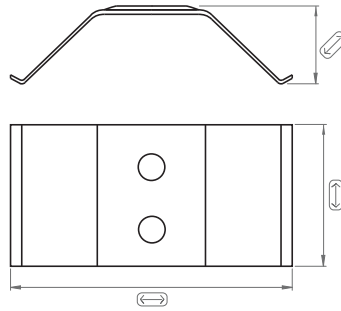

60	122	36

Fecho Macho-Fêmea
Male-Female Lock

978

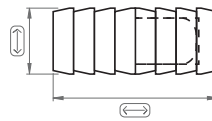

8	20	1000
10	20	1000

Dobradiça para Abas de Mesa
Table Flaps Hinge

E30

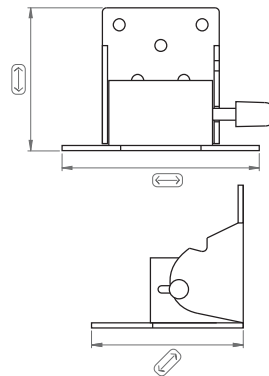

55	82	58,5



E

Dobradiças
Hinges



Dobradiça Quick DTC com Amortecedor
Soft Closing DTC Hinge with Quick System

N15



Calço: Q02 / P87
Base:

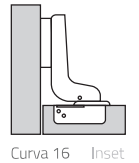
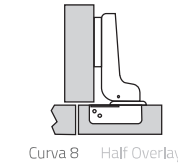
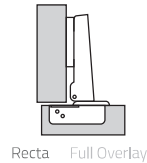
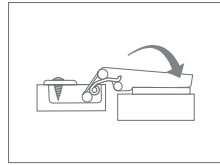
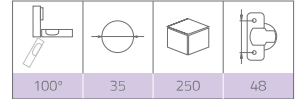

Recta Full Overlay

Curva 8 Half Overlay

Curva 16 Inset

Dobradiça Quick DTC sem Amortecedor
Soft Closing DTC Hinge without Quick System

Q01



Calço: Q02 / P87
Base:

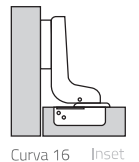
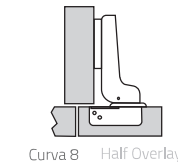
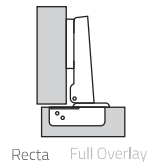
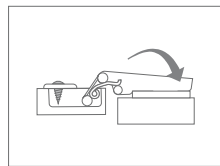
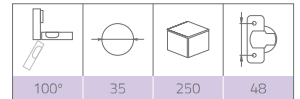

Recta Full Overlay

Curva 8 Half Overlay

Curva 16 Inset

Dobradiça Quick DTC com Amortecedor de 2 Movimentos
2 Movements Soft Closing DTC Hinge with Quick System

Q29



Calço: Q02 / P87
Base:

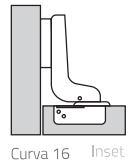
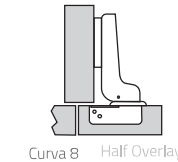
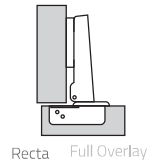
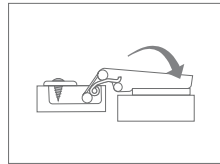
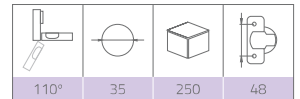

Recta Full Overlay

Curva 8 Half Overlay

Curva 16 Inset

Dobradiça Quick DTC com Amortecedor e Bucha de 2 Movimentos
2 Movements Soft Closing DTC Hinge with Quick System and Dowel

Q30



Calço: Q02 / P87
Base:

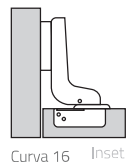
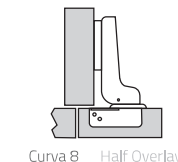
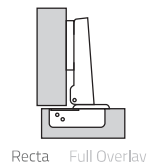
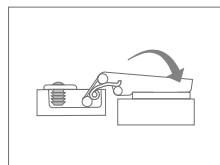
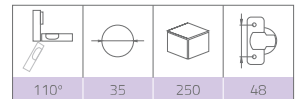

Recta Full Overlay

Curva 8 Half Overlay

Curva 16 Inset

Dobradiça Quick DTC com Amortecedor
Soft Closing DTC Hinge with Quick System

R45



Calço: Q02 / P87
Base:

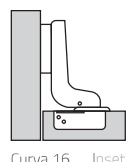
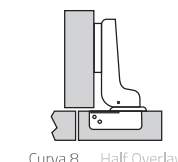
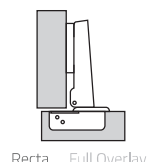
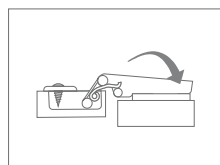
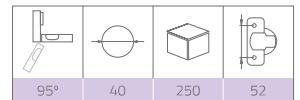

Recta Full Overlay

Curva 8 Half Overlay

Curva 16 Inset

Dobradiça Quick com Amortecedor
Soft Closing Hinge with Quick System

Q76



Calço: S11 / S12
Base:

110°	35	250	48

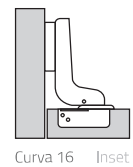
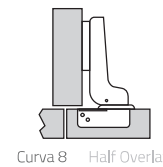
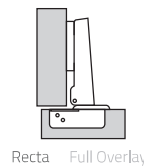
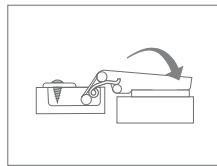

R27



Calço: R28 / R47
Base:

110°	35	250	48

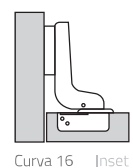
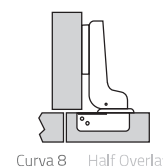
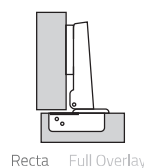
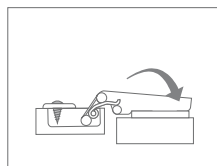

Dobradiça Quick DTC c/Amort. e Regulação de Força
Soft Closing DTC Hinge w/ Strength Regulation

P35



P35
Calço: G44
Base:

P35.B
Calço: G46 / G46.3D
Base:

P35,XXX
Calço: Q02 / P87
Base:

165°	35	100	48

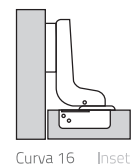
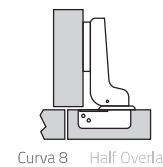
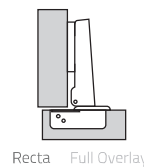

Dobradiça DTC 165°
165° DTC Hinge

G43



G43 / G43.1048 / G43.SM
Calço: G44
Base:

G43.B / G43.1048.B / G43.SM.B
Calço: G46 / G46.3D
Base:

110°	35	250	48

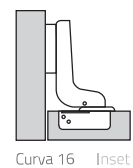
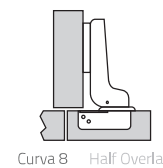
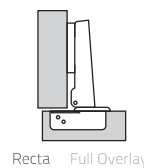
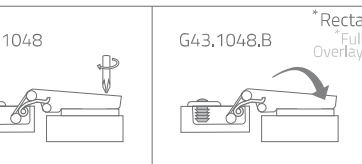

Dobradiça DTC
DTC Hinge

G43	G43.B	G43.1048	G43.1048.B <small>*Recta Full Overlay</small>	G43.SM	G43.SM.B

Dobradiça DTC Mola Invertida
Reverse Spring DTC Hinge

N14



Calço: G44
Base:

110°	35	250	48

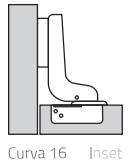
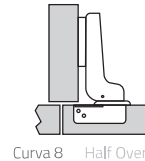
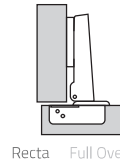
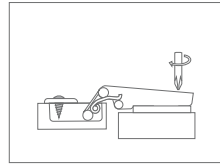

Dobradiça DTC Copo 40 mm
40 mm Cup DTC Hinge

K30



Calço: G44
Base:

110°	40	250	52

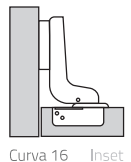
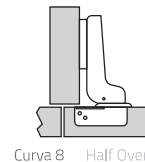
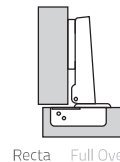
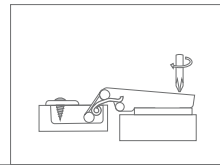

Dobradiça DTC Copo 26 mm
26 mm Cup DTC Hinge

G45



Calço: G46.26
Base:

95°	26	500	38

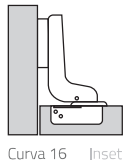
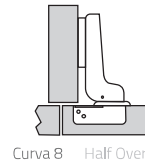
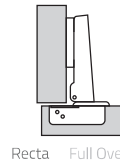
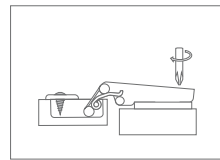

Dobradiça DTC Linear
Linear DTC Hinge

G49



G49.LN
Calço: G44
Base:

G49.LNXXX / G49.LN10
Calço: G46 / G46.3D
Base:

90°	35	250	48

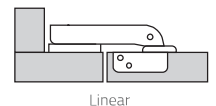
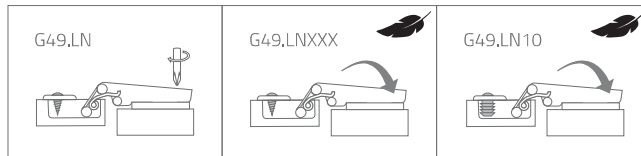

Dobradiça DTC Rabo Curto
Short Arm DTC Hinge

G51



Calço: G46.RC
Base:

110°	35	500	48

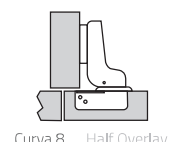
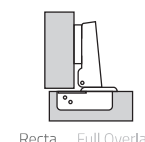
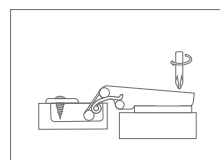

E

Dobradiça Rabo Curto c/ Calço Alto
Short Arm Hinge w/ High Base

J87



110°	35	250	48

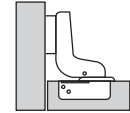
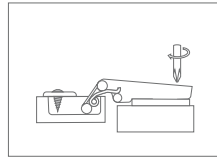

Curva 16 Inset

141



Calço: 085 / 086
Base: 085 / 086

110°	35	250	48

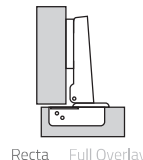
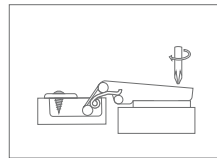

Recta Full Overlay

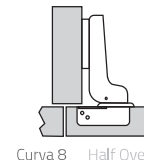

Curva 8 Half Overlay

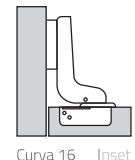

Curva 16 Inset

142



Calço: 085 / 086
Base: 085 / 086

110°	35	100	48

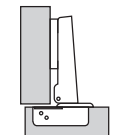
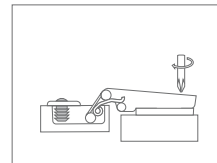

Recta Full Overlay

N10



Calço: M73
Base: M73

110°	35	250	48

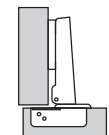
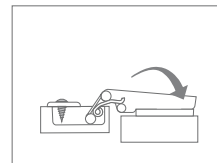

Recta Full Overlay

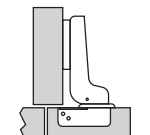

Curva 8 Half Overlay

148



Calço: 085 / 086
Base: 085 / 086

626 Espelho
Cover



92°	35	250	—

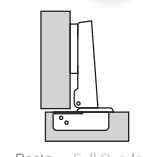
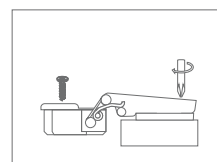

Recta Full Overlay

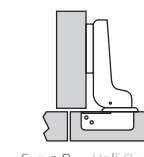

Curva 8 Half Overlay

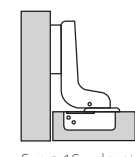

Curva 16 Inset

Dobradiça Porta de Vidro SH
Glass Door SH Hinge

E

Dobradiça Porta de Vidro SH Copo 26mm
Glass Door SH Hinge 26mm Cup

M78



Calço: 077
Base:

078 Espelho
Cover



92°	26	250	—

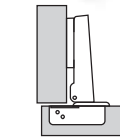
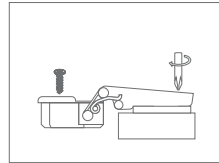

Recta Full Overlay

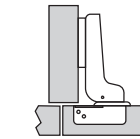

Curva 8 Half Overlay

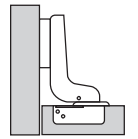

Curva 16 Inset

Dobradiça SH Sem Mola
SH Hinge Without Spring

378



Calço: 085 / 086
Base:

110°	35	250	48

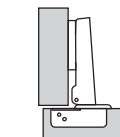
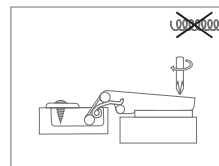

Recta Full Overlay

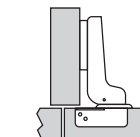

Curva 8 Half Overlay

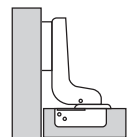

Curva 16 Inset

Dobradiça 180° SH
180° SH Hinge

140



Calço: 085 / 086
Base:

180°	35	100	48

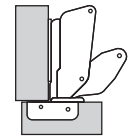
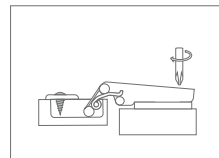

Recta Full Overlay

Dobradiça a 90° SH
90° SH Hinge

746



Calço: 085 / 086
Base:

60°	35	250	48

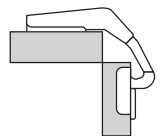
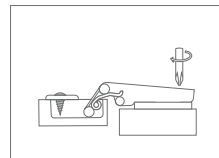

Dobradiça a 45° Invertidos SH
Inverted 45° SH Hinge

M77



Calço: 085 / 086
Base:

45°	35	250	48

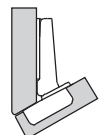
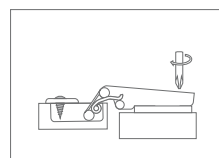

Dobradiça a 30° SH
30° SH Hinge

146



Calço: 085 / 086
Base:

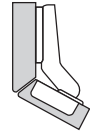
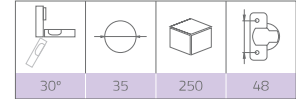
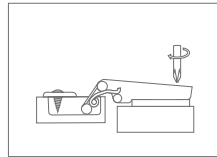

Dobradiça a 45° SH
45° SH Hinge

145



Calço: 085 / 086
Base:

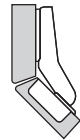
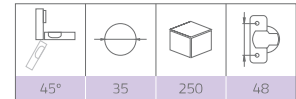
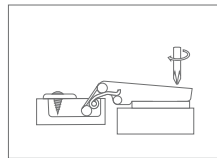

Dobradiça Linear SH
Linear SH Hinge

638



Calço: 085 / 086
Base:

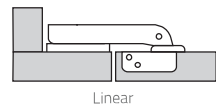
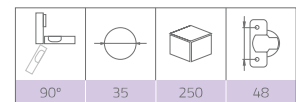
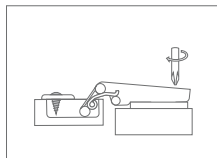

Dobradiça Braço Curto SH
Short Arm Linear SH Hinge

K61

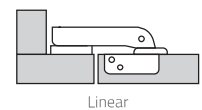
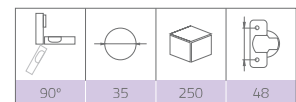
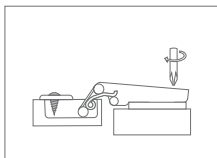

Dobradiça de Escritório Simples p/ Mad. 22 mm
22 mm Wood Simple Office Hinge

M07



Copo
Cup

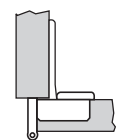
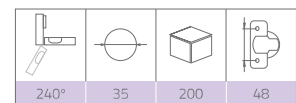
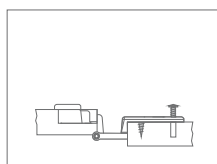

Simple Simple

Dobradiça de Escritório Simples/Dupla p/ Mad. 19 mm
19 mm Wood Simple/Double Office Hinge

869



Copo
Cup



240°	180°	35	200	48
		35	100	48

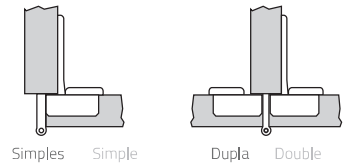
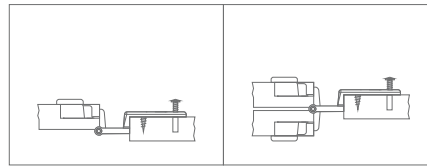

Tampa p/ Dobradiça DTC
DTC Hinge Cover

526



	16	43	500

Calço para Dobradiça SH
SH Hinge Base

086



Alturas:
Height:
2 MM
4 MM
6 MM

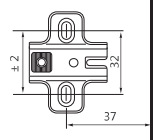
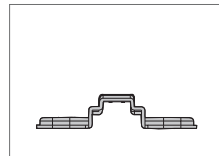

Calço com Paraf. Euro para Dobradiça SH
SH Hinge Base with Euro Screw

085



Alturas:
Height:
2 MM
4 MM
6 MM

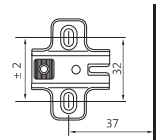
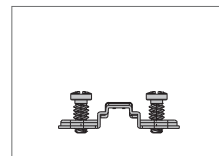

Calço Quick para Dobradiça SH
Quick Base for SH Hinge

M73



Alturas:
Height:
3 MM

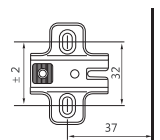
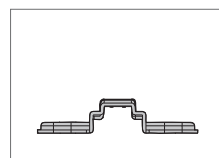
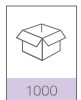

Calço c/ Parafuso 10 mm
10mm Screw Hinge

B85



Alturas:
Height: 4 MM

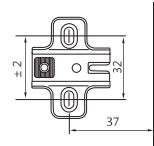
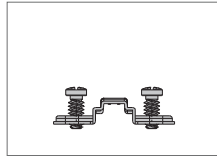

Calço para Dobradiça Copo 26mm SH
Base for SH 26mm Cup Hinge

077



Alturas:
Height: 2 MM

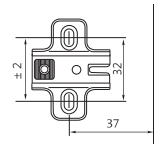
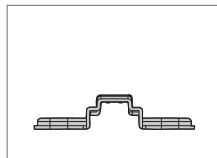

Calço para Dobradiça DTC
DTC Hinge Base

G44



Alturas:
Height: H0
H2

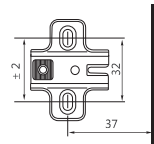
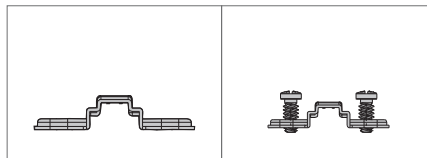

Calço Quick para Dobradiça DTC
Quick Base for DTC Hinge

G46.B



Alturas:
Height: H0
H2

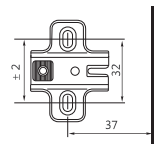
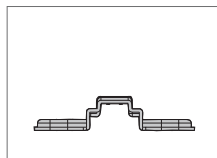

Calço Quick 3D para Dobradiça DTC
3D Quick Base for DTC Hinge

G46.3D



Alturas:
Height: H0

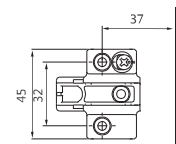
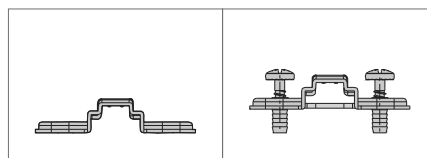

Calço 3D/Normal para Dob. com Amortecedor DTC
3D/Normal Base for DTC Soft Close Hinge

Q02



Alturas:
Height: H0
H2
H4

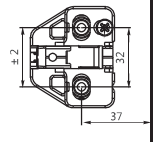
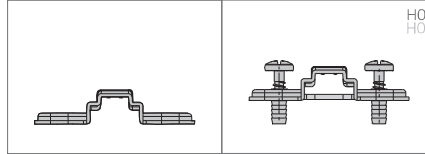

Calço 3D/Normal c/Paraf. Euro para Dob. com Amortecedor DTC
3D/Normal Base with Euro Screw for DTC Soft Close Hinge

P87



Alturas:
Height: H0
H2

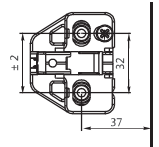
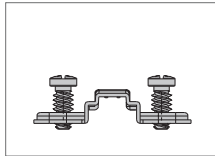

Calço Linear 3D para Dobradiça DTC
DTC 3D Linear Base for DTC Hinge

R28



Alturas:
Height: H0

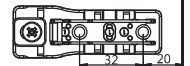
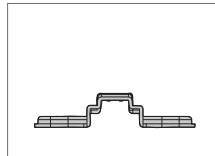

Calço 3D para Dobradiça R27 DTC
DTC 3D Base for R27 Hinge

R47



Alturas:
Height: H0

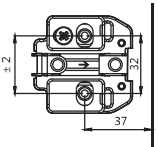
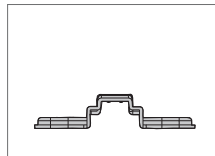

Calço Linear 3d para Dobradiça DTC
DTC 3D Linear Base for DTC Hinge

S83



Alturas:
Height: H0
H2

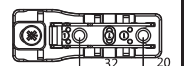
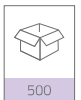
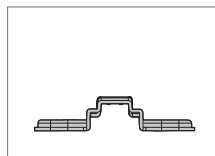

Calço para Dobradiça de Copo 26 mm DTC
DTC Base for 26 mm Cup Hinge

G46



Alturas:
Height: H0
H2

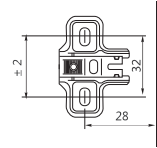
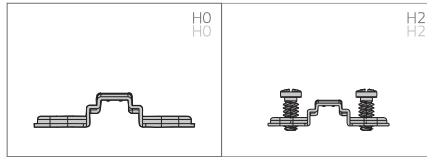

Calço para Dobradiça Rabo Curto
SH Base for Short Arm Hinge

G46



Alturas:
Height: H0

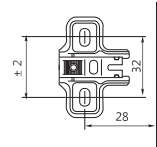
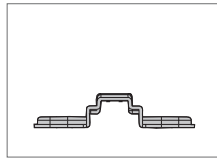

Calço Normal para Dobradiça c/Amort. Blama
Normal Base for Blama Soft Close Hinge

S11



Alturas:
Height: H0
H2

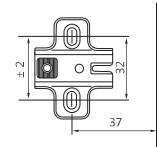
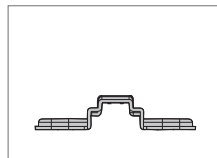

Calço 3D para Dobradiça c/Amort. Blama
3D Base for Blama Soft Close Hinge

S12



Alturas:
Height: H0
H2

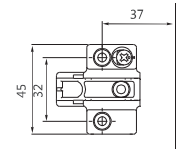
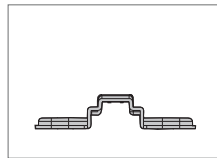

Dobradiça Articulada
Articulated Hinge

116

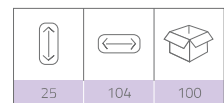
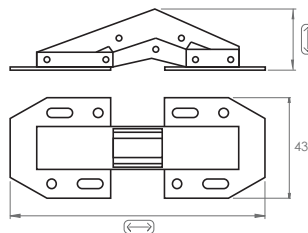

Dobradiça Oval de Embutir
Oval Embed Hinge

L68

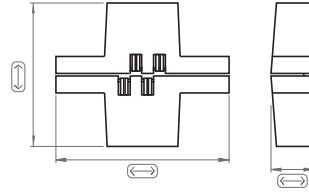

37	44	13	500
42	36	13	500

Dobradiça Oval de Embutir Pottker
Pottker Oval Embed Hinge

L68.PK

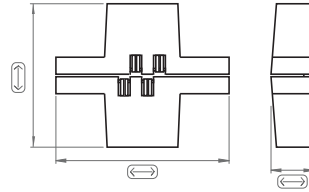

44	38.5	13	2
60	36	13	2
94	55	18	2

Dobradiça Cilíndrica de Embutir Plástico
Cilindric Plastic Embed Hinge

115.123

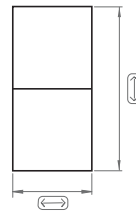

14	40	1000

Dobradiça Cilíndrica de Embutir Latão
Brass Cilindric Embed Hinge

115



12	26.5	50
14	31	50
16	33	50

Dobradiça p/ Portas de Descarril
Hinge for Fall Off Doors

321

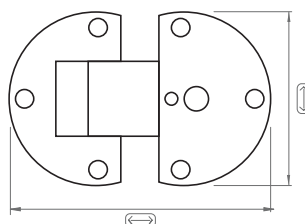

57	37	100

Dobradiça Cromada para Sobreposição de Tapos
Chrome Hinge to Overlap Top

126

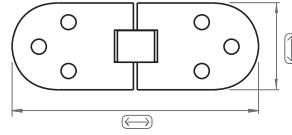

30	79	24

Dobradiça Cromada p/Porta Basculante
Chrome Hinge for Tilting Door

R77

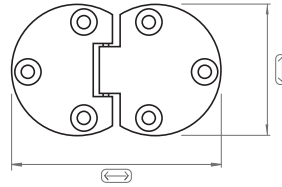

30	47	50

Dobradiça Nickelada
Nickel Hinge

R10

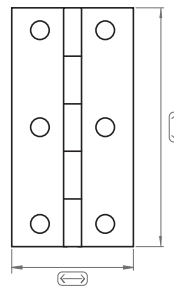

63	32	100

Dobradiça Oxi. Francês
Oxidized Hinge

R08

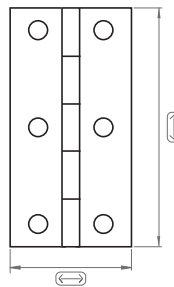

63	32	100

Dobradiça Porta de Vidro
Glass Door Hinge

R37

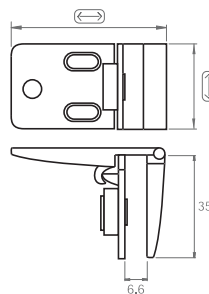

28	46	20

Acabamento: Satinado
Finish: Satin

Dobradiça Porta de Vidro
Glass Door Hinge

R49

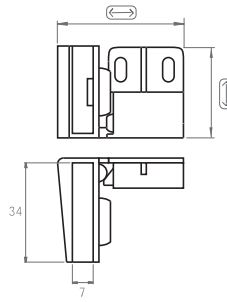

28	42	50

Acabamento: Satinado

Dobradiça Porta de Vidro
Glass Door Hinge

K13

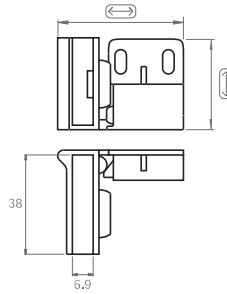

31	45	50

Acabamento: Nickel Mate
Finish: Matte Nickel

Dobradiça Porta de Vidro
Glass Door Hinge

K14

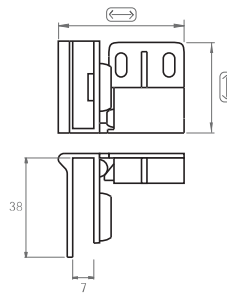

31	45	50

Acabamento: Nickel Mate
Finish: Matte Nickel

Dobradiça Porta de Vidro
Glass Door Hinge

B26

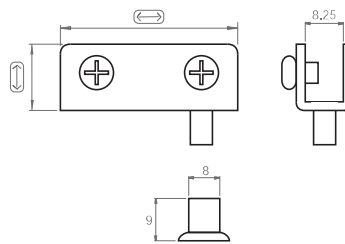

15	40	100

Dobradiça de Giro
Spin Hinge

C61

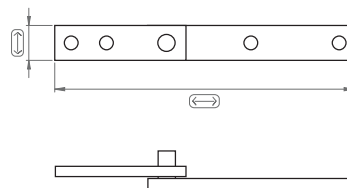

10.1	87	100

Dobradiça Intermédia
Intermediate Hinge

L51

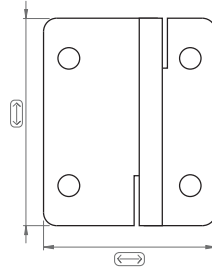

50	41,5	100

Dobradiça Porta Interior Esq. / Dir.
Left / Right Interior Door Hinge

P11

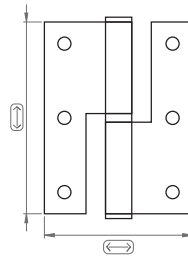

90	70	50

Dobradiça Quick DTC c/Amort. e Regulação de Força p/Espessura 10 mm
10 mm Thickness Wood Soft Closing DTC Hinge w/ Strength Regulation

S86



Calço: R28 / R47
Base:

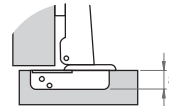

110°	35	250	48

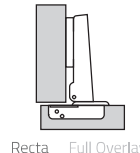
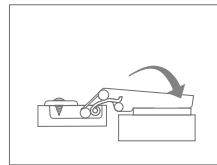

Recta Full Overlay

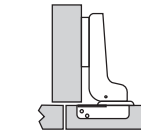

Curva 8 Half Overlay

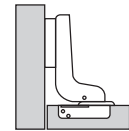

Curva 16 Inset





F

Acessórios de Cozinha
Kitchen Accessories



Canto Mágico com Amortecedor
Soft Closing Magic Corner

PS08



516	860	498

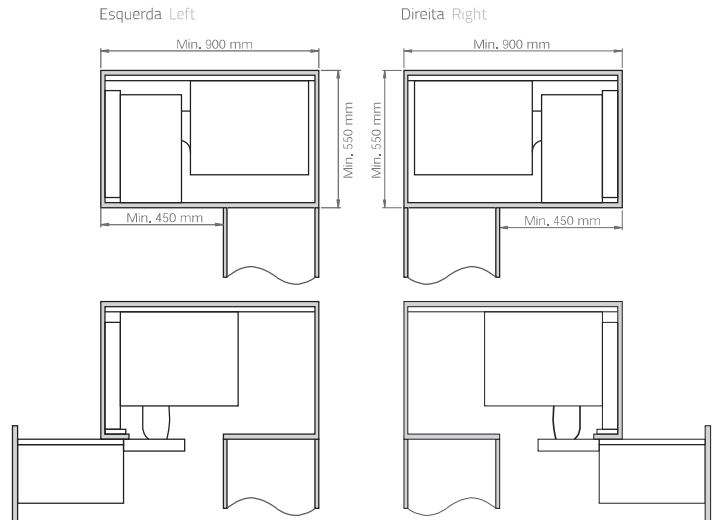

Canto Mágico com Amortecedor
Soft Closing Magic Corner

O32



500	900	480

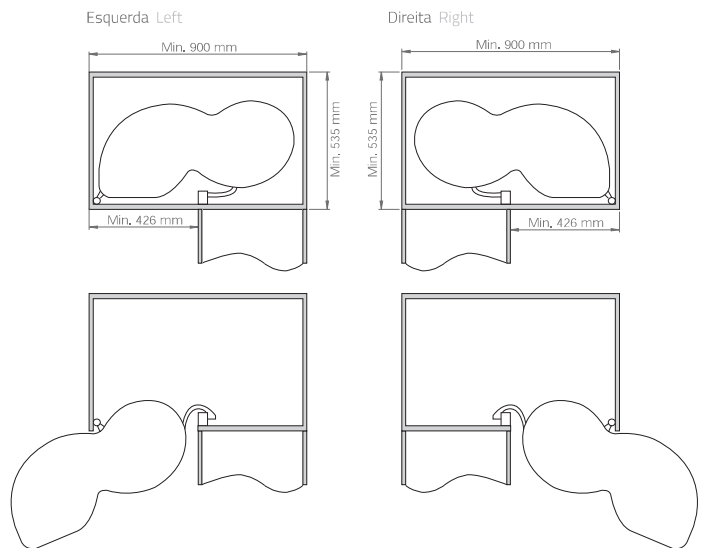

Cesto de Cozinha com Amortecedor
Soft Closing Kitchen Basket

Q80

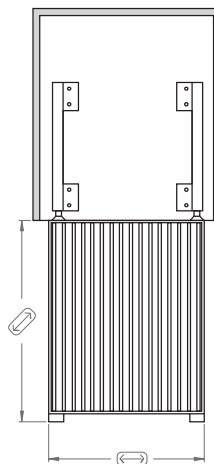

M			
300	500	245	470
350	500	295	470
400	500	345	470
500	500	395	470

Cesto de Cozinha com Amortecedor
Soft Closing Kitchen Basket

Q79

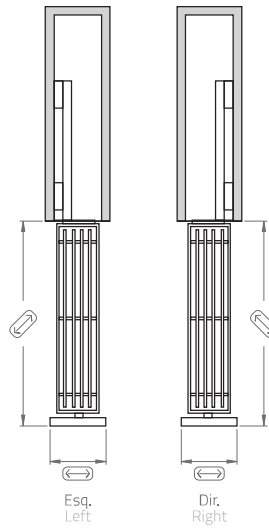

M	↑	←	↗
150	500	110	450
200	500	160	450

525

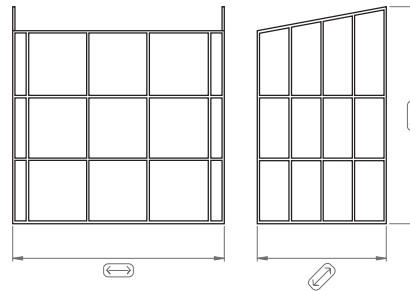

↑	←	↗
420	250	250
420	280	250
420	325	250
420	365	250
420	410	250
420	550	250

Tulha Pintada
Wire Basket

Q75



L	↑	←	↗
13	355	277	277

Balde de Lixo Metálico
Metalic Dustbin

821

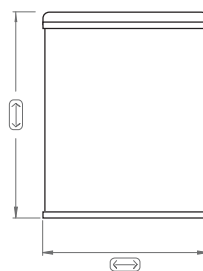

L	↑	←	↗
13	355	277	277

Balde de Lixo em Inox
Stainless Steel Dustbin

F

Balde de Lixo em Alumínio
Aluminium Dustbin

Q70

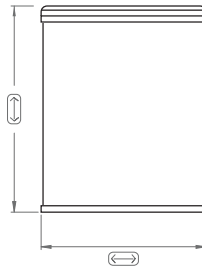

13	355	277	277

Balde de Lixo Plástico
Plastic Dustbin

817

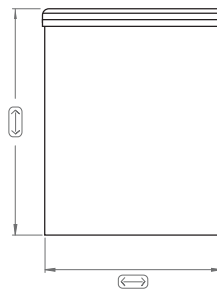

13	355	277	277

Balde de Lixo
Dustbin

530

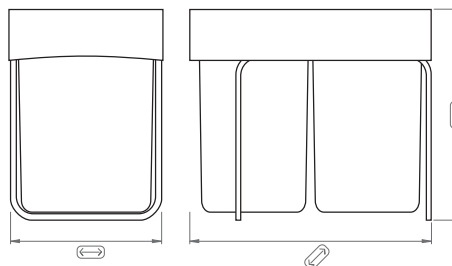

2x14	398	255	450

Balde de Lixo
Dustbin

540

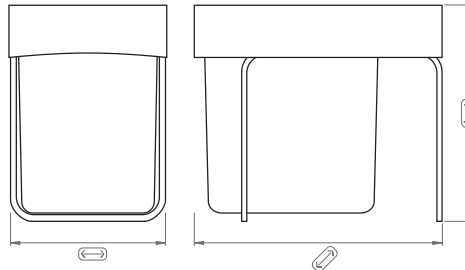

21	398	255	450

Balde de Lixo
Dustbin

Q74

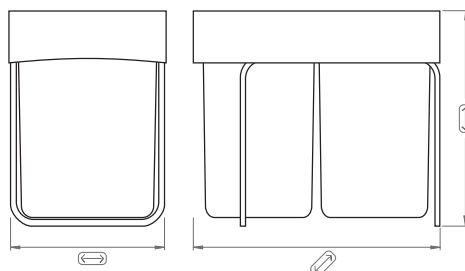

1x16+2x7.5	339	343	473

Balde de Lixo Inox
Stainless Steel Dustbin

Q72

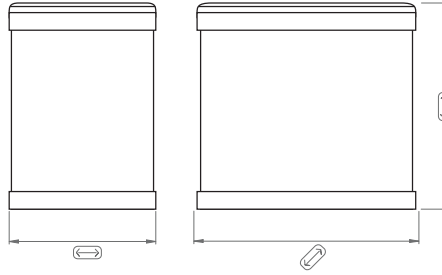

16	333	230	353

Balde de Lixo
Dustbin

Q71

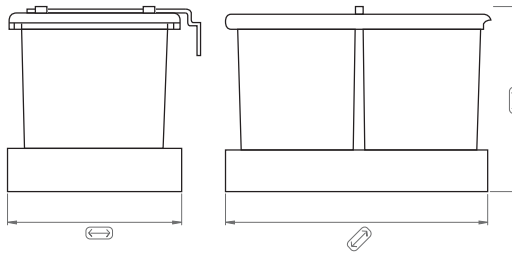

2x16	320	330	470

Balde de Lixo
Dustbin

Q73

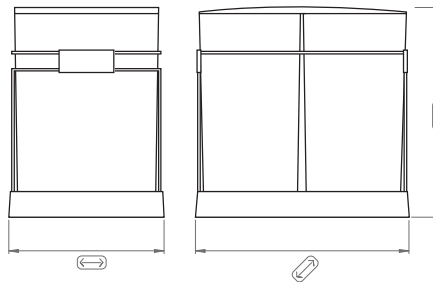

2x30	511	380	493

Balde de Lixo para Gaveta
Drawer Dustbin

M80

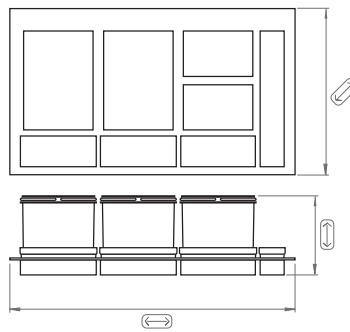

12+2x5.5	230	475-540	415-490
2x12+2x5.5	230	695-740	415-490
2x12+2x5.5	230	794-840	415-490
16+2x7.5	300	380	415-490
2x16+2x7.5	300	380	415-490
2x16+2x7.5	300	380	415-490

Base para Balde de Lixo de Gaveta
Drawer Dustbin Base

R98

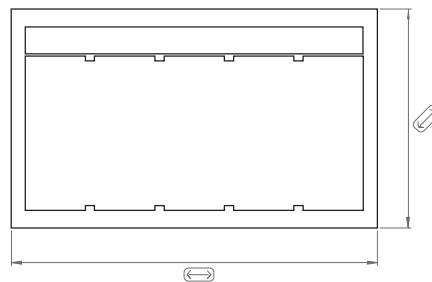

429-540	399-490
730-840	399-490

F

Baldes de Lixo de Gaveta
Drawer Dustbin

R99

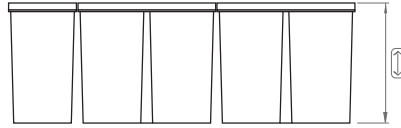

11+26	277
11+2x26	277

Bandeja Salva-Fundos de Alumínio
Aluminium Bottom Protector

E35

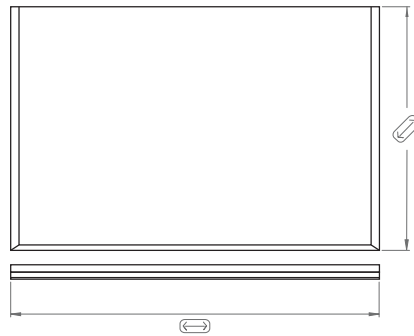

564	560
664	560
764	560
864	560
964	560
1164	560

Bandeja Salva-Fundos de Plástico
Plastic Bottom Protector

R66

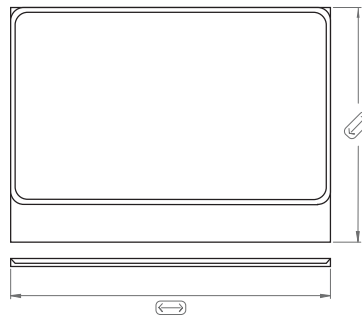

563	470-560
663	470-560
763	470-560
863	470-560
963	470-560
1163	470-560

Porta-Talheres
Cutlery Support

N90

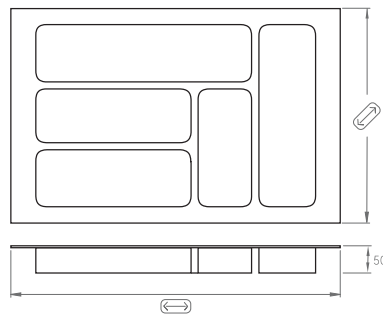

237	480	537	480
287	480	637	480
337	480	737	480
387	480	837	480
437	480	1137	480

Porta-Talheres Antracite
Anthracite Cutlery Support

R97

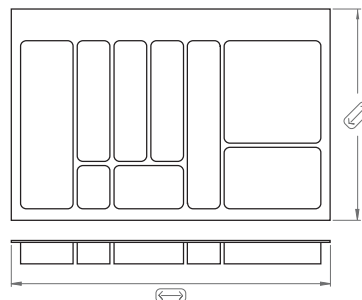

397-451	390-490
497-551	390-490
697-740	390-490
795-840	390-490

Grelha para Rodapé
Kitchen Pannel Grid

546

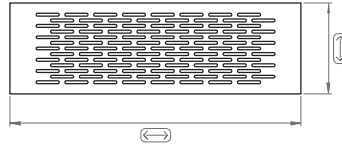

70	224
70	447

Acabamento: Anodiz. Mate
Finish: Matte Anodized

Rodapé de Cozinha
Kitchen Pannel

N61

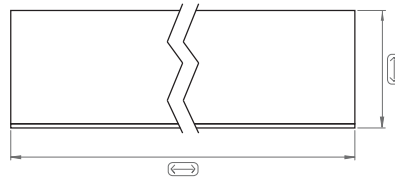

		Cores: Colors:	
100	4000		<input type="radio"/>
120	4000		<input type="radio"/>
150	4000	<input type="radio"/>	

Canto Fixo para Rodapé de Cozinha
Kitchen Pannel Fixed Corner

D46

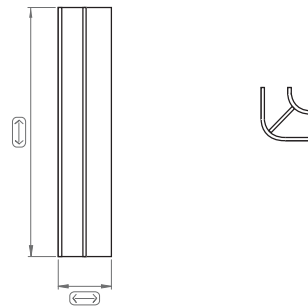

		Cores: Colors:	
150	32		<input type="radio"/>
			<input type="radio"/>

Canto Flex para Rodapé de Cozinha
Kitchen Pannel Flex Corner

K51

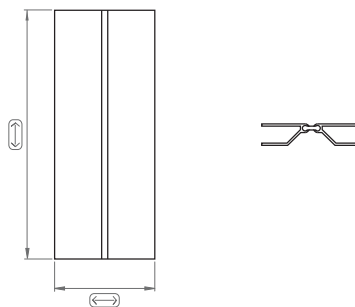

		Cores: Colors:	
150	56		<input type="radio"/>
			<input type="radio"/>

União para Rodapé de Cozinha
Kitchen Pannel Link

R70

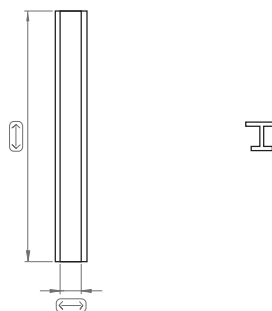

		Cores: Colors:	
150	12		<input type="radio"/>
			<input type="radio"/>

F

Terminal para Rodapé de Cozinha
Kitchen Pannel Terminal

R71

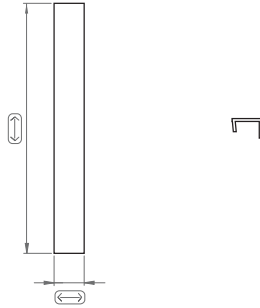

		Cores: Colors:
150	17	

Grelha para Forno
Oven Cover

K64

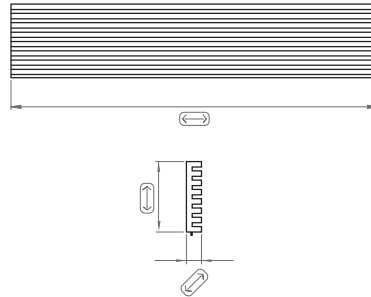

120	595	25

Acabamento: Alumínio / Inox
Finish: Aluminium / Stainless Steel

Grelha para Micro-Ondas
Microwave Cover

380

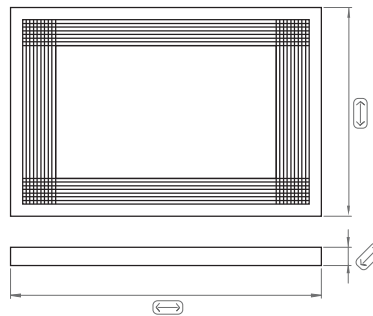

400	595	35

Acabamento: Branco / Inox / Castanho
Finish: White / Stainless Steel / Brown

Nivelador Duplo de Cozinha
Double Kitchen Leveler

G25

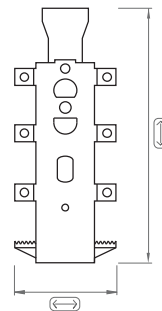

150	58

Nivelador de Cozinha Esq./Dir.
Left/Right Kitchen Leveler

R25

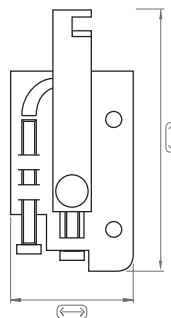

88	41

Tampa para Nivelador de Cozinha Esq./Dir.
Left/Right Kitchen Leveler Cover

R26

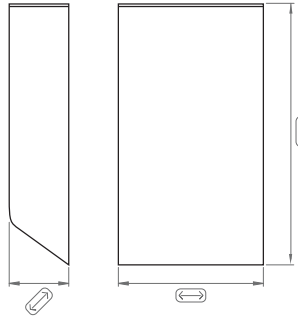

			Cores: Colors: ●
77	43	12	

Nivelador DTC
DTC Leveler

S64

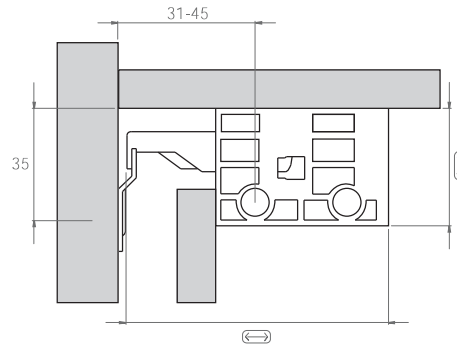

		Cores: Colors: ○
33	78	

Chapa p/ Nivelador DTC
DTC Leveler Plate

875

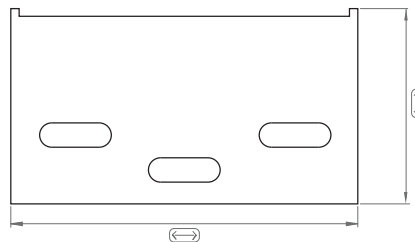

36	64

Nivelador DTC
DTC Leveler

S66

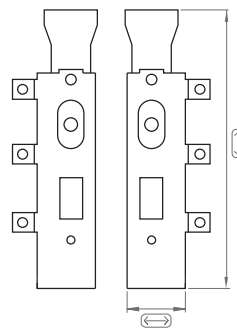
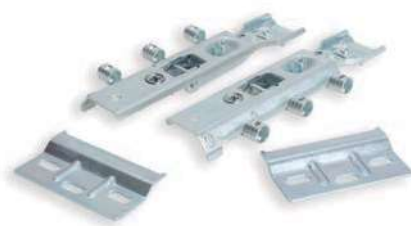

143	31

Suporte de Pano
Cloth Hanger

Q26

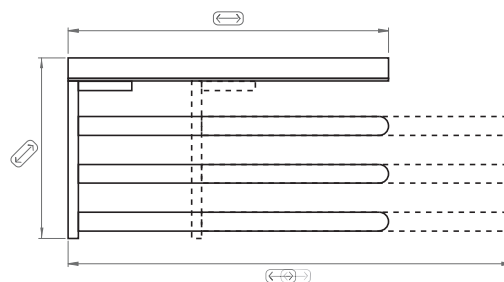

173	465	79	829
173	465	124	829
173	465	169	829

Suporte de Pano
Cloth Hanger

Q27

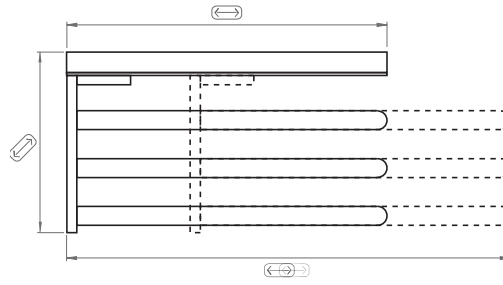

173	465	71	772
173	465	95	772
173	465	140	772

Suporte de Detergentes Fundo
Deep Soap Hanger

Q24

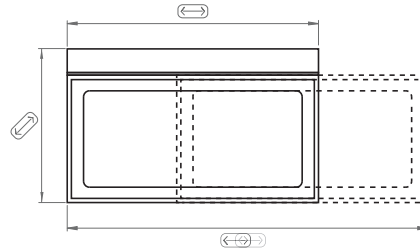

173	465	173	775

Suporte de Detergentes Baixo
Low Soap Hanger

Q25

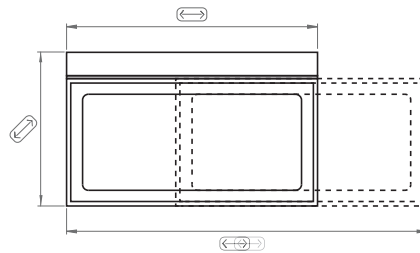

173	465	173	775

Pia de Aço Inoxidável
Stainless Steel Kitchen Sink

S18.44

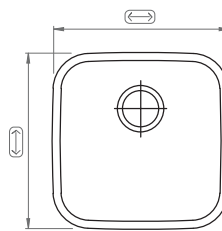

150	58

Pia de Aço Inoxidável
Stainless Steel Kitchen Sink

S18.54

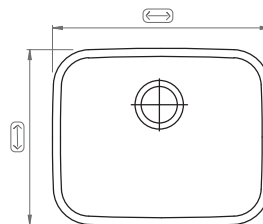

88	41

Pia de Aço Inoxidável
Stainless Steel Kitchen Sink

S19

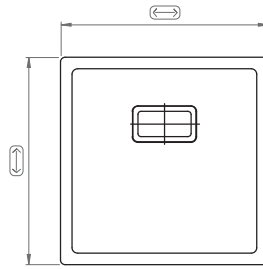

77	43	12

S16

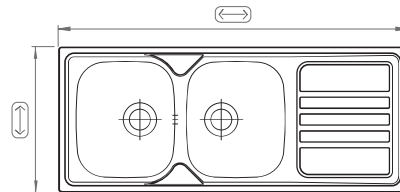
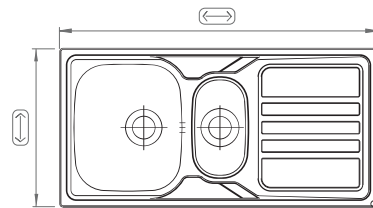
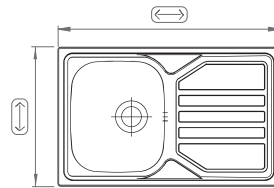

500	800
500	1000
500	1200

Lava-Loiça de Encastrar em Aço Inoxidável
Embed Dishwasher in Stainless Steel

S17

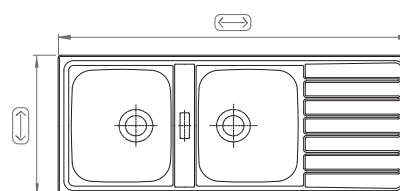
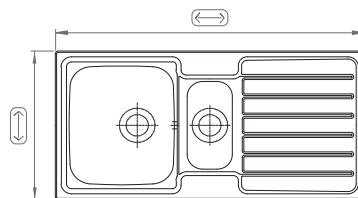
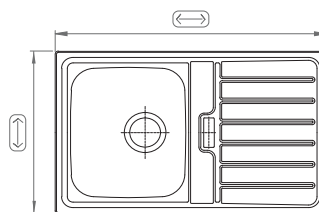

500	800
500	1000
500	1200

Lava-Loiça de Encastrar em Aço Inoxidável
Embed Dishwasher in Stainless Steel

F





Perfis de Alumínio
Aluminium Profiles



Perfil de Alumínio
Aluminium Profile

L79

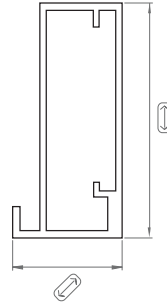

45	41.00	21.3

Acabamento: Anodiz. Natural / Cromado
Finish: Natural Anodized / Chrome

Perfil de Alumínio
Aluminium Profile

M62

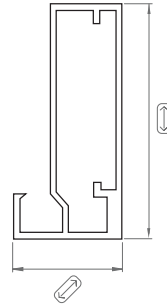

45	41.00	20.8

Acabamento: Anodizado Natural
Finish: Natural Anodized

Perfil de Alumínio
Aluminium Profile

SASEC006

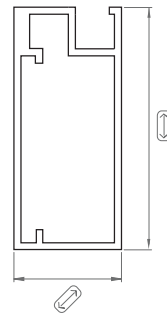

45.6	41.00	20.4

Acabamento: Anodizado Natural
Finish: Natural Anodized

Esquadro para Perfil de Alumínio
Aluminium Profile Square

L80

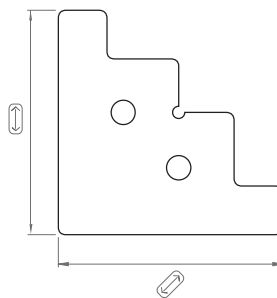

60	60

Perfil de Alumínio M.S.
M.S. Aluminium Profile

C36

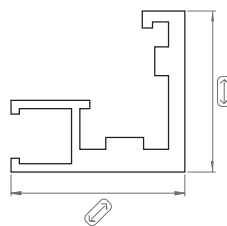

21.3	41.00	23.5

Acabamento: Anodizado Natural / Inox
Finish: Natural Anodized / Inox

Perfil de Alumínio M.S.
M.S. Aluminium Profile

C37

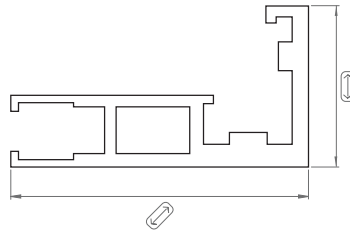

21,3	4100	38,4

Acabamento: Anodizado Natural / Inox
Finish : Natural Anodized / Inox

C41



Calço: 085 / 086
Base:

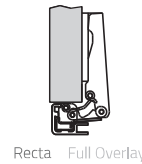
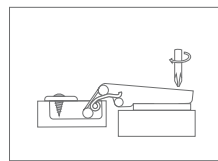

Recta

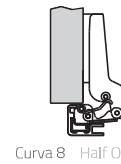

Full Overlay

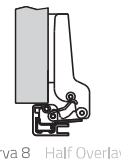

Curva 8 Half Overlay

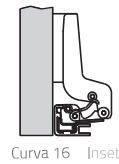

Curva 16 Inset

110°	200

Dobradiça Perfil M.S.
M.S. Profile Hinge

C42.35

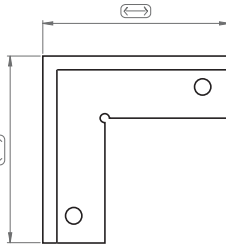

35	35	250

Esquadro de Ligação M.S.
M.S. Connection Square

C42.43

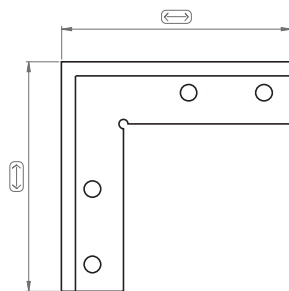

43	43	250

Esquadro de Ligação M.S.
M.S. Connection Square

G61

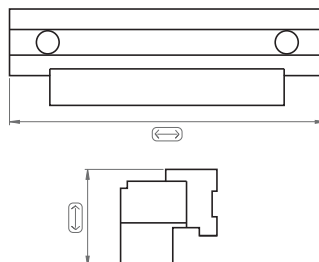

17	54	250

Base p/Fixar Compasso
Lifting System Fixing Base

G

Perfil de Vidro
Glass Protection Profile

C43

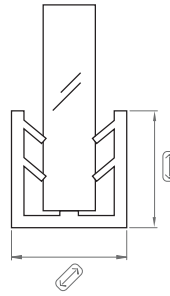

6.6	2500	6.5

Para Perfil: M62 / SASEC006
For Profile: C36 / C37

Perfil de Cobertura
Cover Profile

C44

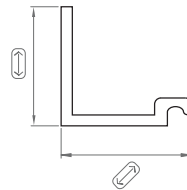

13	2500	14

Para Perfil: C36 / C37

Perfil de Vidro
Glass Protection Profile

L81

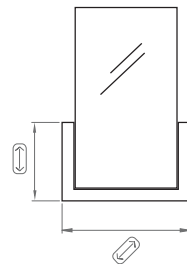

3,2	2700	5,2

Para Perfil: L79

Perfil de Alumínio
Aluminium Profile

E15.S

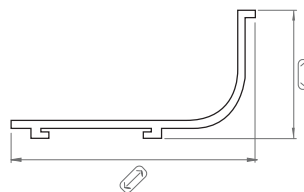

25	5000	44

Acabamento: Mate / Branco
Finish: Matte / White

R64 Terminal



Perfil de Alumínio
Aluminium Profile

E15.D

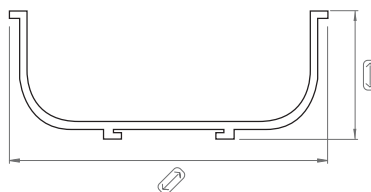

25	5000	57.6

Acabamento: Mate / Branco
Finish: Matte / White

R65 Terminal



Esquadro para Perfil de Alumínio
Aluminium Profile Square

Q98

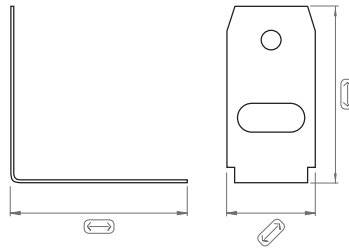

40	40	20

Perfil Alumínio Gola Duplo
Aluminium Double Collar Profile

R92

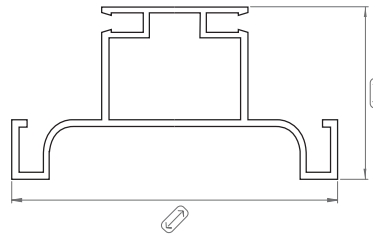

35	2500	66,4

Acabamento: Anodizado Natural
Finish: Natural Anodized

Perfil Alumínio Gola Simples
Aluminium Simple Collar Profile

R93

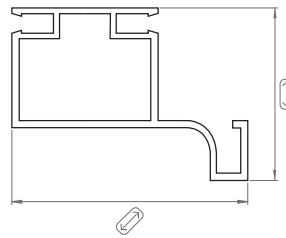

35	2500	48

Acabamento: Anodizado Natural
Finish: Natural Anodized

Perfil Puxador de Alumínio
Aluminium Handle Profile

R48

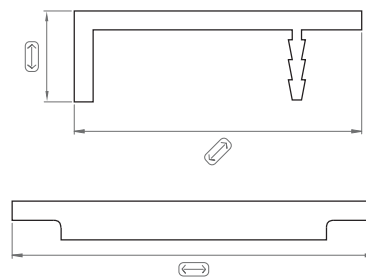

12	296	38
12	346	38
12	396	38
12	446	38
12	496	38
12	596	38
12	696	38
12	789	38
12	896	38
12	996	38
12	1196	38
12	3000	38

Acabamento: Anod. Natural / Nickel Satin.
Finish: Natural Anodized / Satin Nickel

Perfil Puxador de Alumínio P/Modulo Superior C/Bat. Borracha
Handle Profile for Upper Module W/Rubber Stop

R94

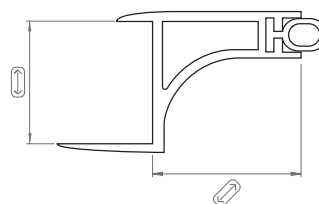

16,2	2500	20

Acabamento: Anodizado Natural
Finish: Natural Anodized

Perfil Puxador de Alumínio
Aluminium Handle Profile

016

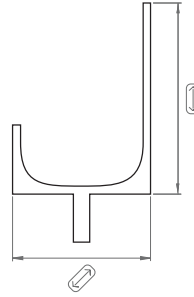
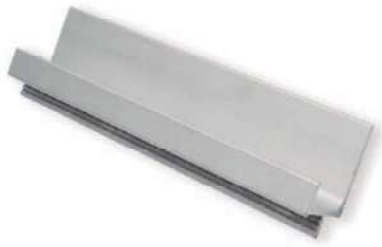

29.8	4100	21

Acabamento: Anodizado Natural
Finish: Natural Anodized

Perfil de Alumínio
Aluminium Profile

020

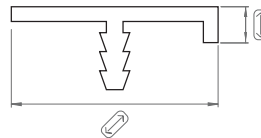

8,5	4100	21,2

Acabamento: Anodizado Natural
Finish: Natural Anodized

Perfil de Orlar Escovado
Brushed Edge Profile

P20

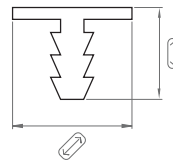

5,6	3200	7,3

Acabamento: Anodiz. Natural / Cromado
Finish: Natural Anodized / Chrome

Perfil de Plástico Cromado
Chrome Plastic Profile

N58

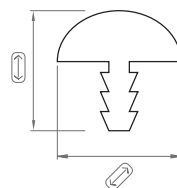

13	2500	14

Acabamento: Cromado
Finish: Chrome

Perfil de Embutir de Alumínio
Aluminium Embed Profile

N77

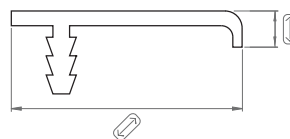

8,7	2500	34

Acabamento: Anodizado Natural
Finish: Natural Anodized

Perfil de Alumínio P/Modulo Lava-Loiça
Dishwasher Module Aluminium Profile

R95

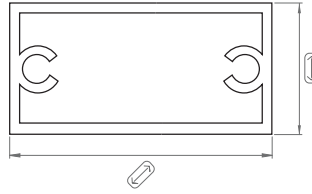

15	2500	30

Acabamento: Anodizado Natural
Finish: Natural Anodized

Terminal de Alumínio P/Perfil R95
Aluminium Terminal for R95 Profile

R96

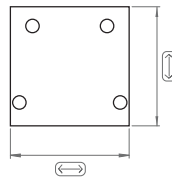

30	30

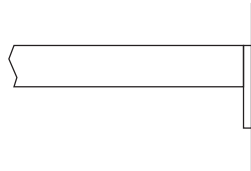

G

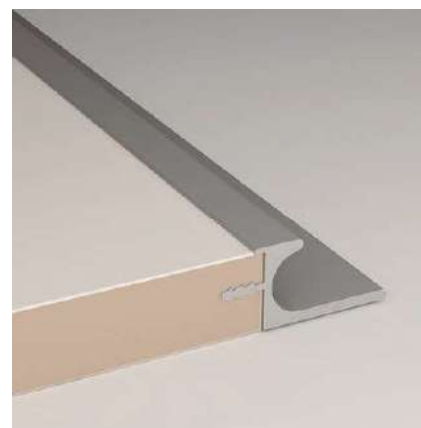
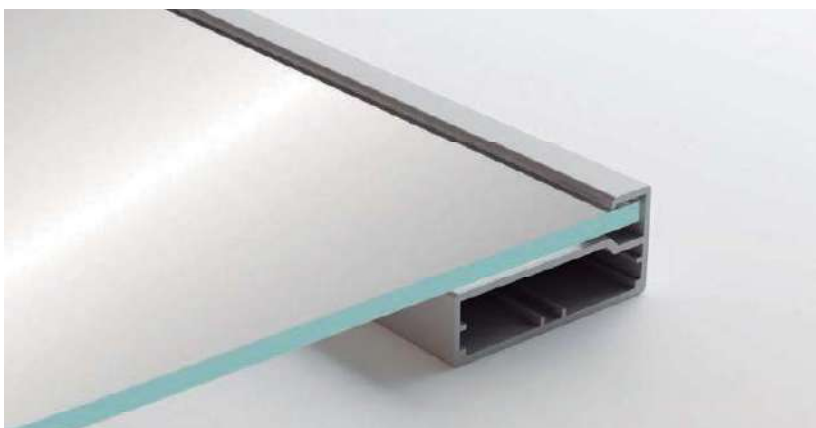
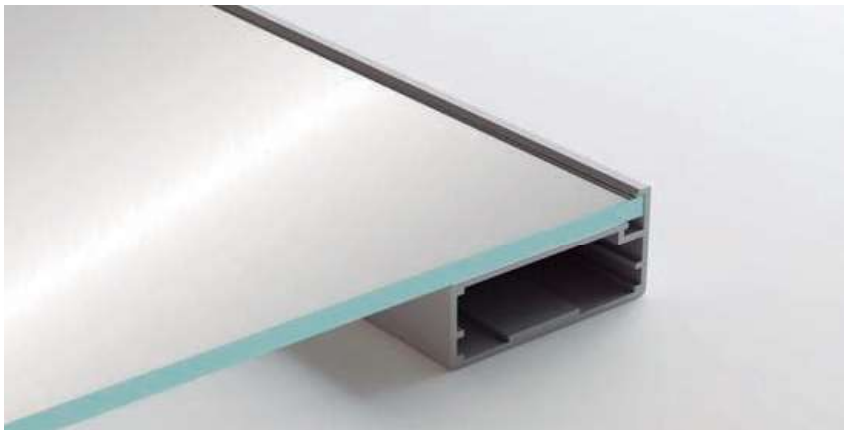



H

Iluminação
Lighting



Ficha Extraível 3 Fichas
3 Plugs Extractable Power Plug

Q99

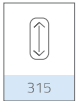
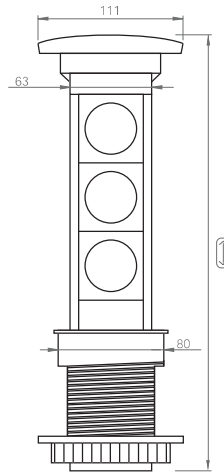

Tomada Extraível 3 Fichas + 2 USB
3 Plugs + 2 USB Extractable Power Plug

S39

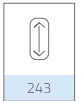
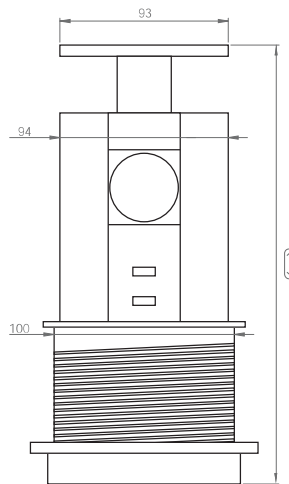

Tomada Extraível com 1 Ficha + 2 USB
1 Plug + 2 USB Extractable Power Plug

S37

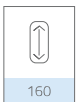
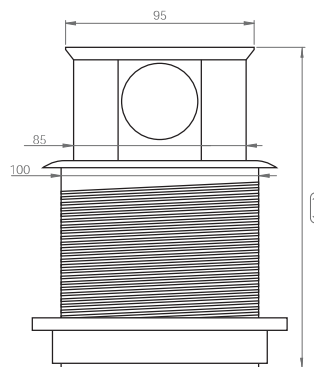

Tomada Extraível 3 Fichas + 2 USB
3 Plugs + 2 USB Extractable Power Plug

S38

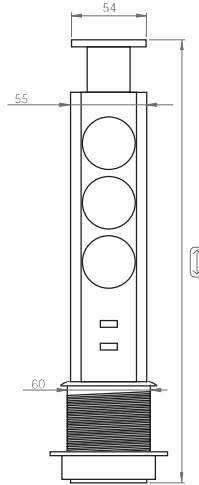

Tomada C/ Tampa 1 Fichas + 1 USB
1 Plugs + 1 USB Power Plug w/ Cover

S40

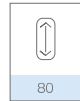
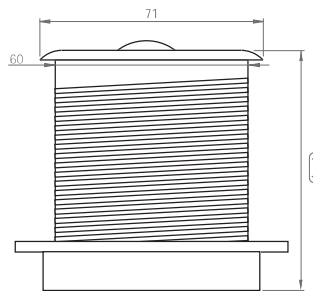

Sensor de Movimento p/LED
Motion Sensor for LED

S13

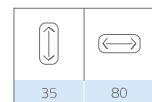
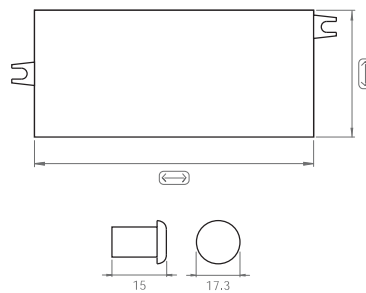

Barra de Alumínio com Led
Led Aluminium Bar

P40

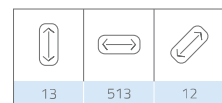
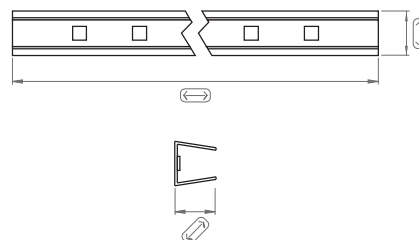

H

Perfil Alumínio + Perfil Acrílico + Terminal
Aluminium Profile + Acrylic Profile + Terminal

S43

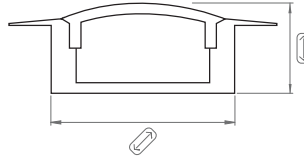

8,5	4000	17,3

Perfil Alumínio + Perfil Acrílico + Terminal
Aluminium Profile + Acrylic Profile + Terminal

S44

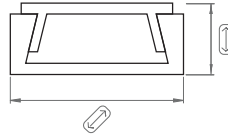

6,5	4000	15,8

Perfil Alumínio + Perfil Acrílico + Terminal
Aluminium Profile + Acrylic Profile + Terminal

S45

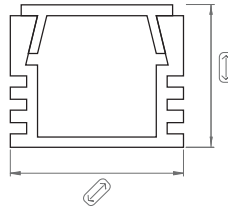

13	4000	15,8

Perfil Alumínio + Perfil Acrílico + Terminal
Aluminium Profile + Acrylic Profile + Terminal

S48

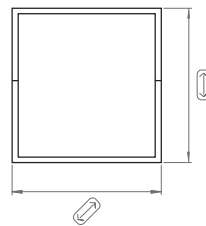

19,7	4000	19,7

Perfil Alumínio + Perfil Acrílico + Terminal
Aluminium Profile + Acrylic Profile + Terminal

S46

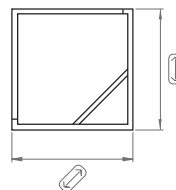

16	4000	16

H

Perfil Alumínio + Perfil Acrílico + Terminal
Aluminium Profile + Acrylic Profile + Terminal

S47

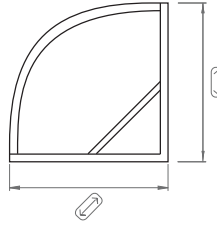

16	4000	16

827

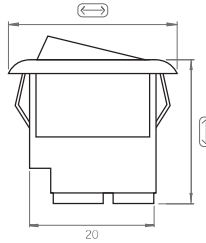

		Cores: Colors: ● ○
22	24	

Interruptor
Switch

Q49

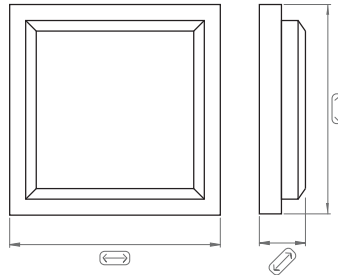

44	44	25

Projektor Led Quadrado
Square Led Projector

Q47

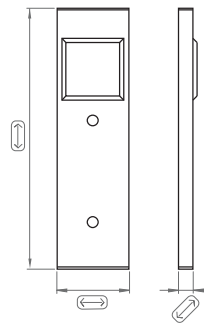

218	60	12

Projektor Rectangular Led com Sensor
Rectangular Led Projector with Sensor

Q48

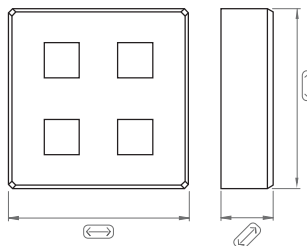

38	38	11

Projektor Led Mini
Mini Led Projector

H

Projektor Led Redondo
Round Led Projector

P38

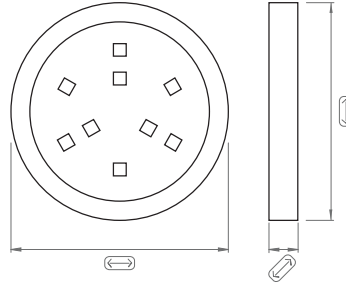

60	60	8

Rolo de Led s/Silicone Branco / Amarelo
White / Yellow Led Roll without Silicone

Q93

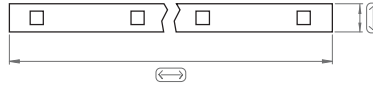

8	5000

Rolo de Led c/Silicone
Led Roll with Silicone

P12

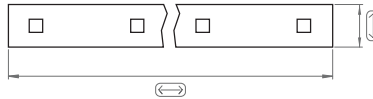

12	5000

Transformador para Led's 6W
6W Led's Transformer

Q50

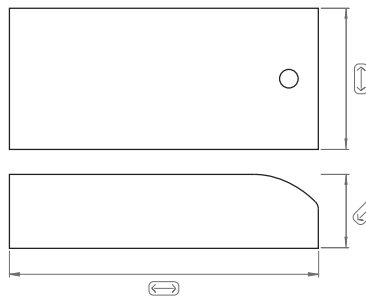

41	92	20

Transformador para Led's 8W / 15W
8W / 15W Led's Transformer

P36

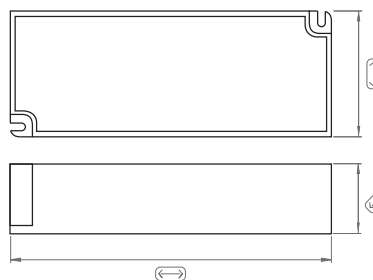

45	115	25

H

Q51

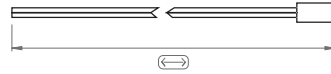

↔
200
1000



H



Sistemas de Roupeiro
Wardrobe Systems

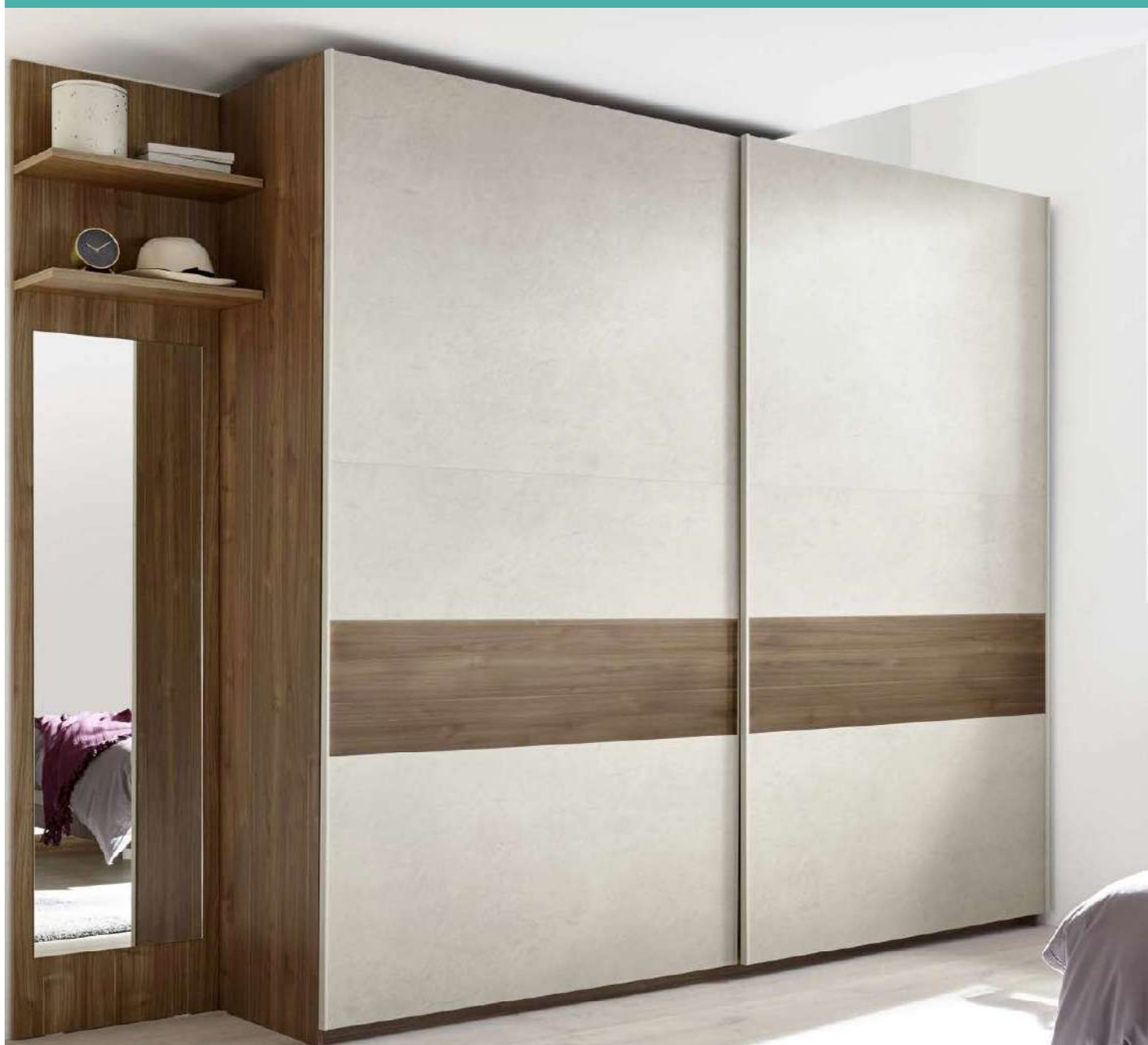

Perfil Superior para Jogo de Correr S55
Upper Profile for Sliding Door Kit S55

S50

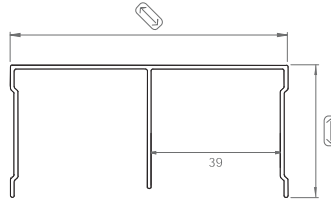

39.8	3000	83.7
39.8	6000	83.7

Acabamento: Anodizado Natural
Finish: Natural Anodized

Perfil Inferior para Jogo de Correr S55
Lower Profile for Sliding Door Kit S55

S51

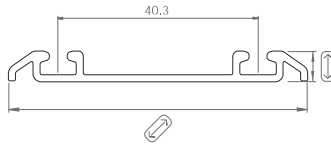

6.4	3000	60
6.4	6000	60

Acabamento: Anodizado Natural
Finish: Natural Anodized

Perfil Inferior para Jogo de Correr S55
Lower Profile for Sliding Door Kit S55

S52

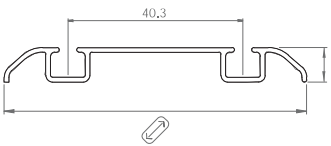

7.9	3000	69.4
7.9	6000	69.4

Acabamento: Anodizado Natural
Finish: Natural Anodized

Perfil Superior para Jogo de Correr S56
Upper Profile for Sliding Door Kit S56

S53

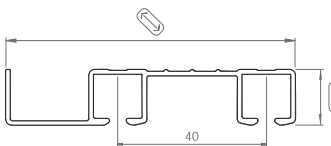

15	3000	78
15	6000	78

Acabamento: Anodizado Natural
Finish: Natural Anodized

Perfil Inferior para Jogo de Correr S56
Lower Profile for Sliding Door Kit S56

S54

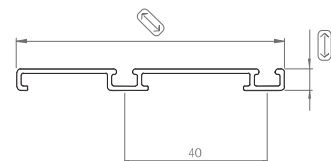

6	3000	75
6	6000	75

Acabamento: Anodizado Natural
Finish: Natural Anodized

Perfil Inferior/Superior para Jogo de Correr S56
Lower/Upper Profile for Sliding Door Kit S56

S61

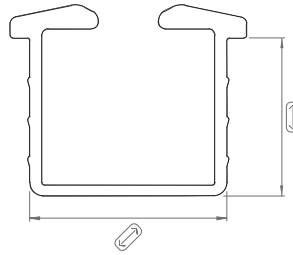

12	3000	15
12	6000	15

Acabamento: Anodizado Natural
Finish: Natural Anodized

Jogo para Porta de Correr 15-30 Kg
15-30 Kg Sliding Door Kit

S56

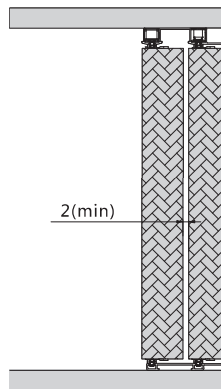

35	1

Jogo para Porta de Correr 30-50 Kg
30-50 Kg Sliding Door Kit

S55

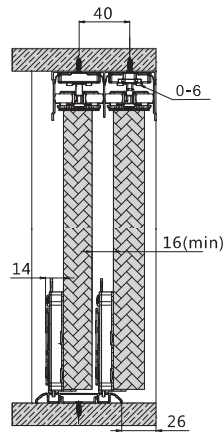

50	1

Roleta Superior para Porta de Correr
Sliding Door Lower Wheel

Q85

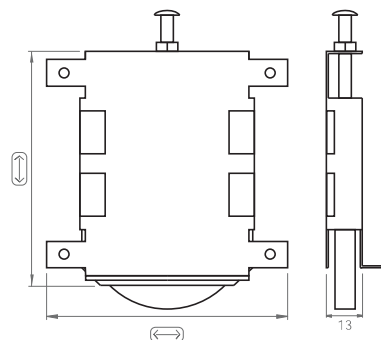

87	90

Roleta Superior para Porta de Correr
Sliding Door Upper Wheel

Q86

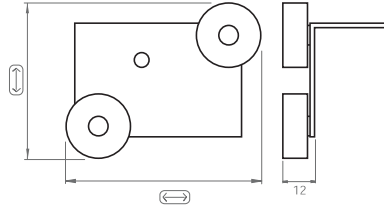

38	50

Perfil Inferior de Porta de Correr
Sliding Door Lower Profile

Q83

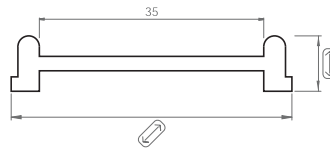

8,5	5000	43

Acabamento: Anodizado Natural
Finish: Natural Anodized

Perfil Superior de Porta de Correr
Sliding Door Upper Profile

Q84

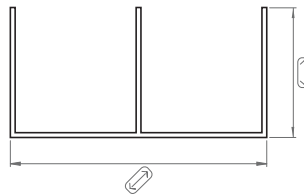
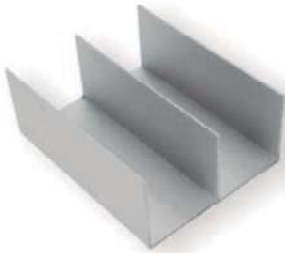

8,5	5000	43

Acabamento: Anodizado Natural
Finish: Natural Anodized

Perfil Puxador Redondo
Round Handle Profile

Q81

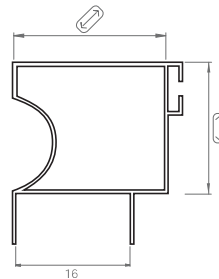

19	5000	23

Acabamento: Anodizado Natural
Finish: Natural Anodized

Perfil Puxador Reto
Square Handle Profile

Q82

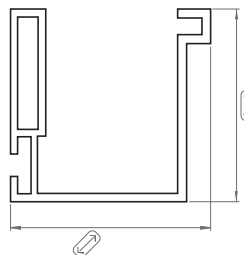

28	5000	28

Acabamento: Anodizado Natural
Finish: Natural Anodized

Perfil U para Roupeiro
U Shape Wardrobe Profile

S26

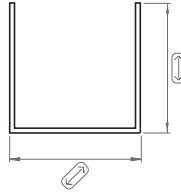

15	5000	18,5

Acabamento: Anodizado Natural
Finish : Natural Anodized

Perfil H para Roupeiro
H Shape Wardrobe Profile

S27

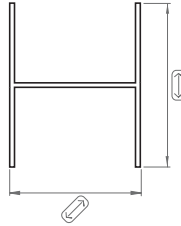

20	5000	18,5

Acabamento: Anodizado Natural
Finish : Natural Anodized

Jogo Int. e Ext. para Porta de Correr Evo 2
Evo 2 Sliding Door Int. and Ext. Set

Q37

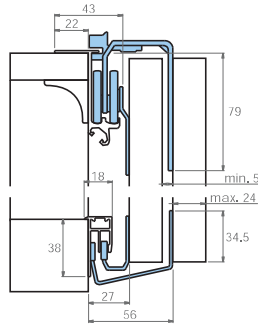
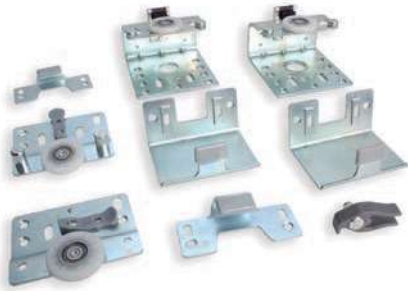

50	1

Jogo Int. para Porta de Correr Evo 2
Evo 2 Sliding Door Int. Set

Q38

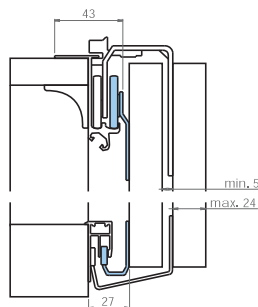

50	1

Calha Superior para Porta de Correr Evo 2
Evo 2 Sliding Door Upper Profile

Q39

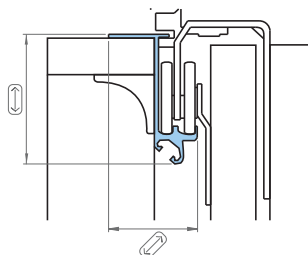

62	4500	43

Acabamento: Anodizado Natural
Finish : Natural Anodized

Calha Inferior para Porta de Correr Evo 2
Evo 2 Sliding Door Lower Profile

Q40

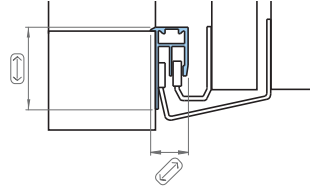

38	4500	18

Acabamento: Anodizado Natural
Finish: Natural Anodized

Amort. Ext. para Porta de Correr Evo 2
Evo 2 Sliding Door External Damper Kit

Q43

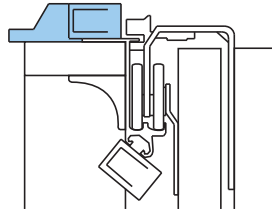

88	1

Amort. Int. para Porta de Correr Evo 2
Evo 2 Sliding Door Internal Damper Kit

Q42

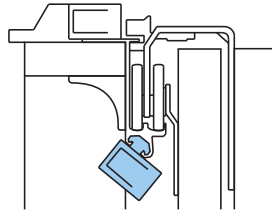

88	1

Ativador de Amort. para Porta de Correr Evo 2
Evo 2 Sliding Door Damper Activating Device

Q44

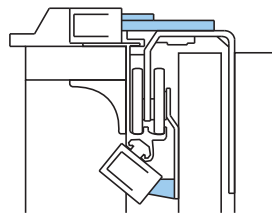

1

Calha Superior para Porta de Correr Evolution
Evolution Sliding Door Upper Profile

N100

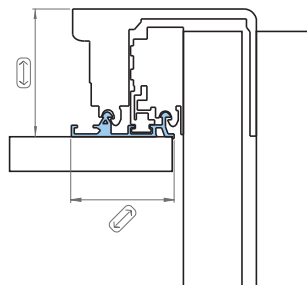

74	3000	57

Acabamento: Anodizado Natural
Finish: Natural Anodized

Calha Inferior para Porta de Correr Evolution
Evolution Sliding Door Lower Profile

N99

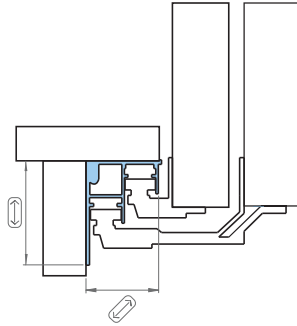
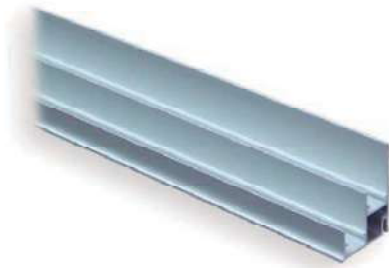

60	3000	41,5

Acabamento: Anodizado Natural
Finish: Natural Anodized

Jogo Interior para Porta de Correr Evolution
Evolution Sliding Door Interior Set

N96.INT

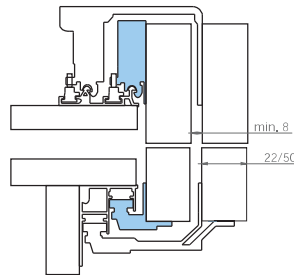

50	1

Jogo Exterior para Porta de Correr Evolution
Evolution Sliding Door Exterior Set

N96.EXT

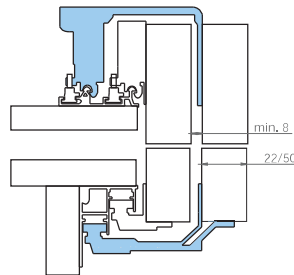

50	1

Travão para Porta de Correr Evolution
Evolution Sliding Door Brake

N96.TR

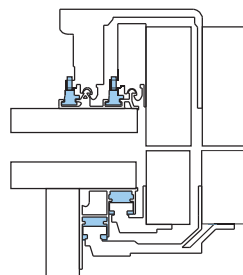
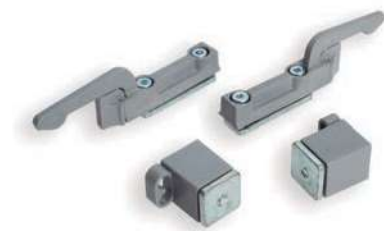

1

Jogo para Porta de Correr Lite 60 Retrac
Lite 60 Retrac Sliding Door Set

Q63

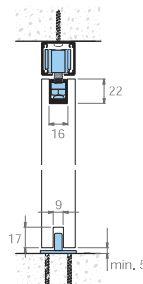

60	2

Calha para Porta de Correr Lite 60
Profile for Lite 60 Sliding Door

Q62

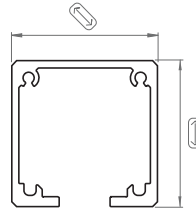

30	3000	30	2

Jogo para Porta de Correr Lite 60 Superior
Lite 60 Superior Sliding Door Set

Q65

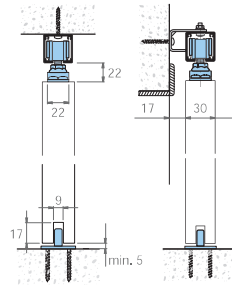

60	2

Suporte de Parede para Lite 60 Superior
Lite 60 Superior Wall Support

Q64

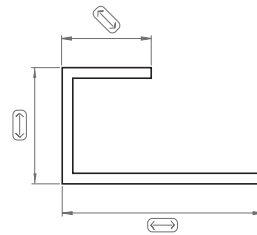

22	38	17	2

Jogo para Porta de Correr K-30
K-30 Sliding Door Set

721

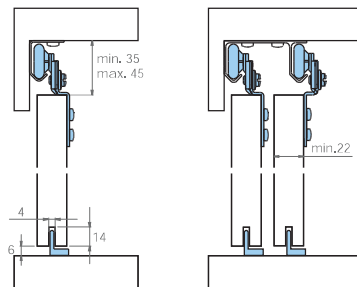

30	10

Calha Dupla para Porta de Correr K-30
Double Profile for K-30 Sliding Door

723

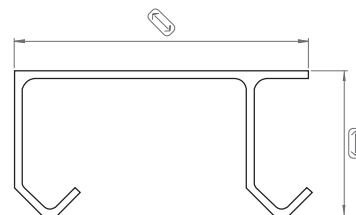

26,4	2000	53	10
26,4	3000	53	10

Calha Simples para Porta de Correr K-30
Single Profile for K-30 Sliding Door

191

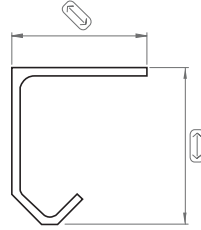

26	2000	21,2	10
26	3000	21,2	10

Jogo para Porta de Correr NK-45
NK-45 Sliding Door Set

P71

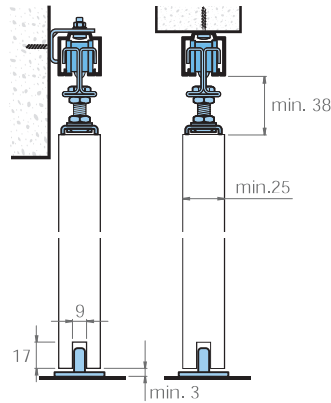

45	10

Calha para Porta de Correr NK-45
Profile for NK-45 Sliding Door

841

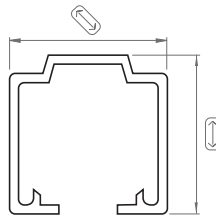

28	3000	27,8	2

Jogo para Porta de Correr Slidpar 25
Slidpar 25 Sliding Door Set

E61

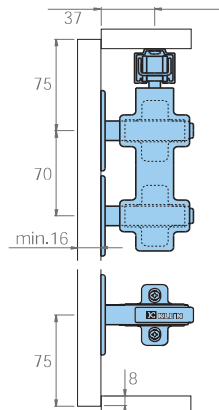

25	1

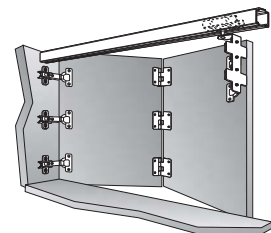

Calha para Porta de Correr NK-80
Profile for NK-80 Sliding Door

941

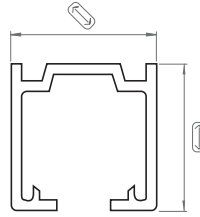
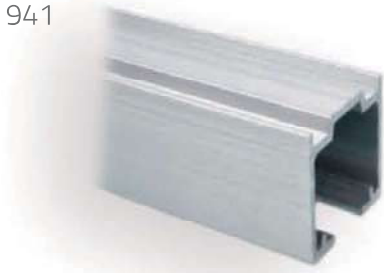

29	3000	28,2	2

Jogo para Porta de Correr Slid 60
Slid 60 Sliding Door Kit

A10

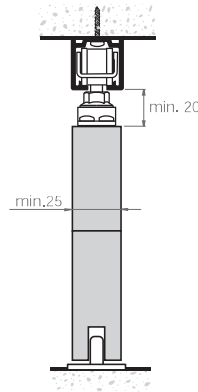

60-85	2

Jogo para Porta de Correr Roll 22
Roll 22 Sliding Door Set

041

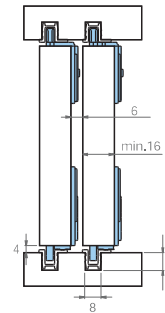

22	20

Jogo para Porta de Correr Roll 42
Roll 42 Sliding Door Set

042

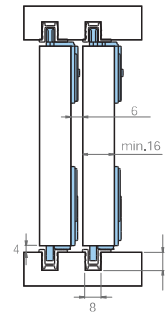

42	20

Calha para Porta de Correr Roll 22 / 42
Profile for Roll 22 / 42 Sliding Door

192

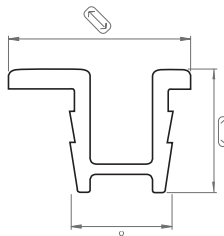

				Cores: Colors: ● ○ ● ○
10	2000	14,5	20	
10	3000	14,5	20	

Travão para Porta de Correr Roll 22 / 42
Roll 22 / 42 Sliding Door Stopper

248

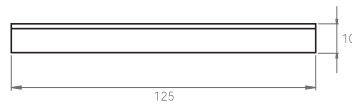

Jogo para Porta de Correr Roll 25
Roll 25 Sliding Door Set

227.25

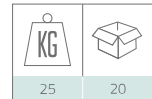
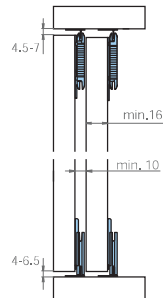

Jogo para Porta de Correr Roll 45
Roll 45 Sliding Door Set

227.45

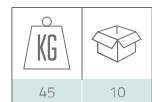
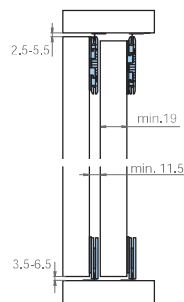

Calha para Porta de Correr Roll 25/45
Profile for Roll 25/45 Sliding Door

618

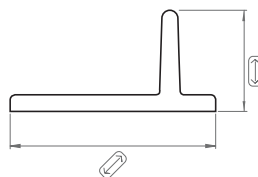

9	2000	18	20
9	3000	18	20

Jogo para Porta de Correr 40 Kg
40 Kg Sliding Door Kit

054

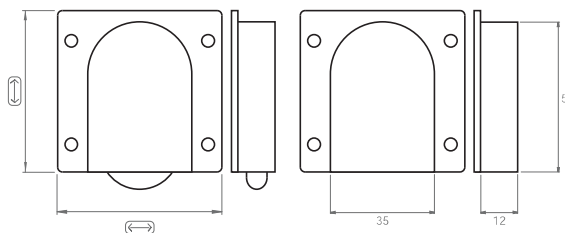

54	56	200

Jogo para Porta de Correr 20 Kg
20 Kg Sliding Door Kit

L43

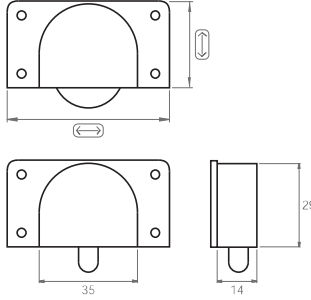

31	58	100

Perfil Inferior para Porta de Correr
Sliding Door Lower Profile

L45

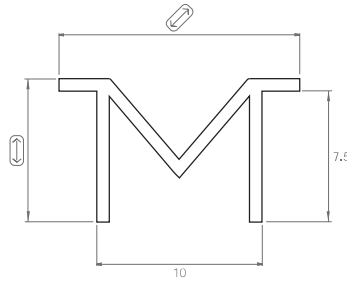

8,7	2000	14,5	50
8,7	3000	14,5	50
8,7	5000	14,5	50

Acabamento: Anodizado Natural
Finish: Natural Anodized

Perfil Superior para Porta de Correr
Sliding Door Upper Profile

L46

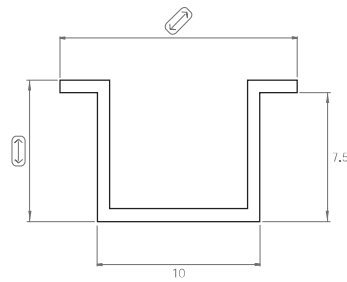

8,7	2000	14,5	50
8,7	3000	14,5	50
8,7	5000	14,5	50

Acabamento: Anodizado Natural
Finish: Natural Anodized

Jogo para Porta de Correr OMGE
OMGE Sliding Door Kit

226

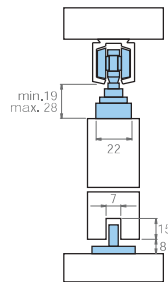

40	1

Calha para Jogo de Correr OMGE
Profile for OMGE Sliding Door Kit

607

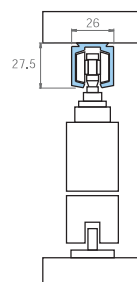

3300	10

Cesto de Chapa Prefurada Ext. Total c/Amortecedor
Soft Closing Full Ext. Storage Box

S32

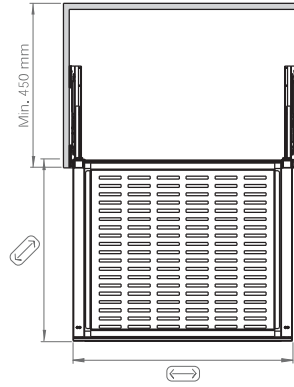

150	564	443
150	864	443

Porta Calças com 6/9 Barras Ext. Total c/Amortecedor
Soft Closing Full Ext. Trousers Rack

S33

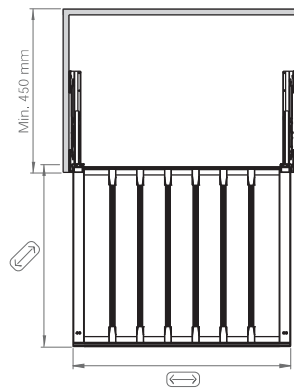

60	564	443
60	864	443

S30

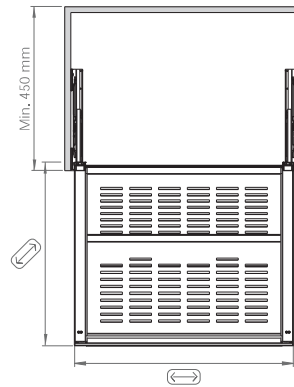

Rack Sapatos Ext. Total c/Amortecedor
Soft Closing Full Ext. Shoes Rack

180	564	443
180	864	443

S31

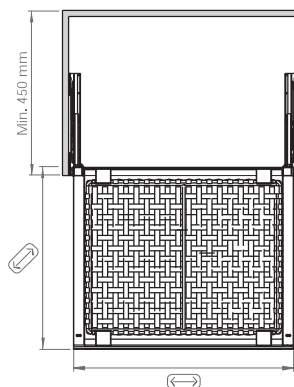

Cesto de Verga Ext. Total c/Amortecedor
Soft Closing Full Ext. Rattan Storage Basket

170	564	443
170	864	443

Espelho Rebátivel
Rotating Mirror

S30

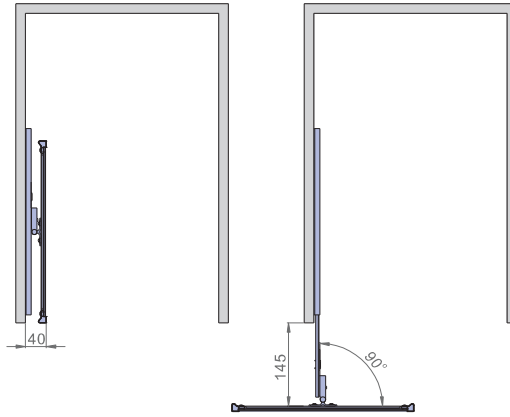

1000	40	300

Varão de Roupeiro
Wardrobe Tube

958

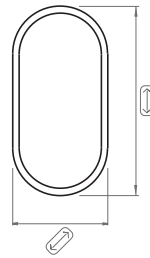

30	4000	15	40

Suporte Central de Varão de Roupeiro
Wardrobe Tube Central Support

J80

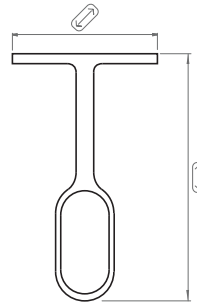

72	40.8	1000

Suporte Lateral Zamak para Varão de Roupeiro
Zamak Side Support for Wardrobe Tube

015

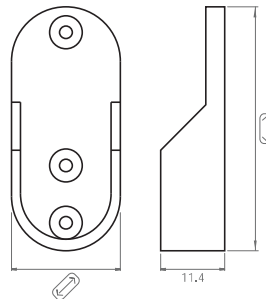

43.5	19.5	1000

Suporte Lateral Plástico para Varão de Roupeiro
Plastic Lateral Support for Wardrobe Tube

512

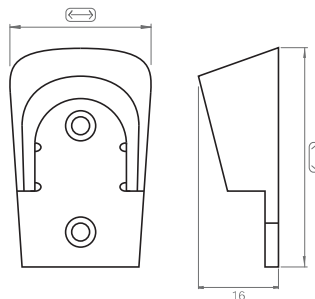

43	29	500

Suporte Lateral Plástico c/Bucha para Varão de Roupeiro
Plastic Lateral Support w/Dowel for Wardrobe Tube

513

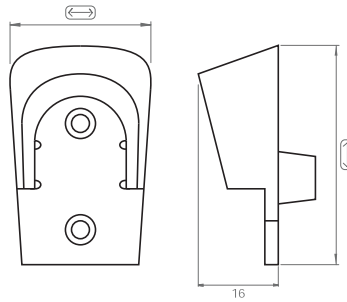

43	29	500

Suporte de Calças com 11 Braços
Trousers Support with 11 Arms

N24

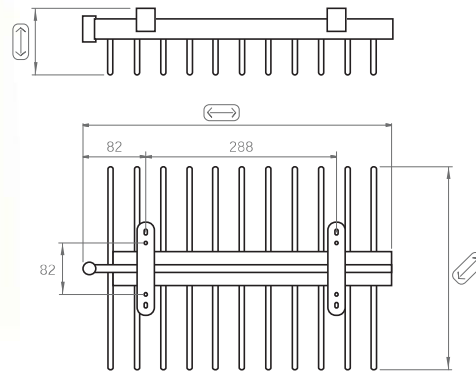

100	470	340	10

Suporte de Calças Lateral com 9 Braços
Side Mounting Trousers Support with 9 Arms

N67

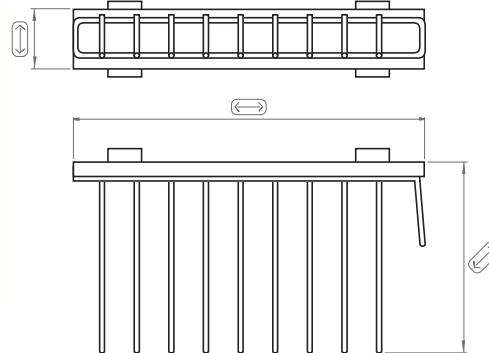

82	485	310	10

Suporte Basculante para Roupeiro
Tilting Support for Wardrobe

N68

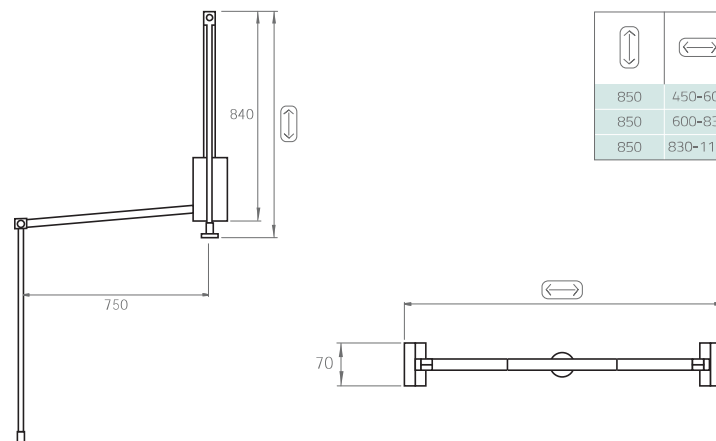

850	450-600	6
850	600-830	6
850	830-1150	6

Perfil de Embutir para Persiana
Shutter Embed Profile

F93

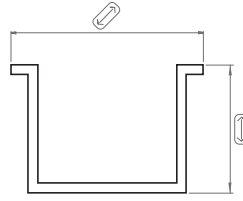

10	2000	15

Perfil Técnico para Persiana
Shutter Profile

F94

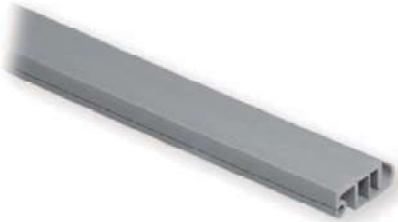

22	2000	10

Curva de Ligação para Perfil de Persiana
Connection Curve for Shutter Profile

F95

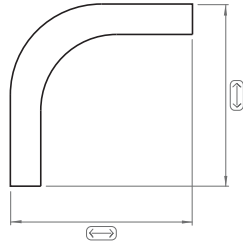

60	60



Laterais de Sapateira
Shoe Closet

J69

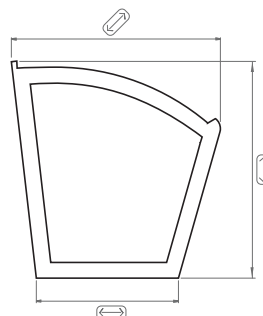

265	150	270	35

Esticador de Porta
Door Tensioner

J88

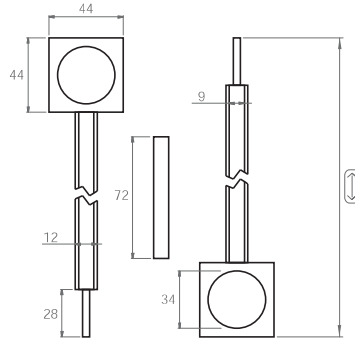

980	50

Cabide Extraível
Extractable Hanger

G86

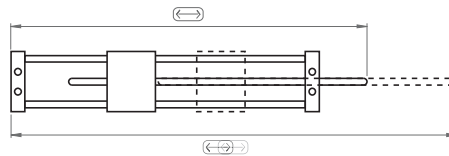

280	65	410	20
330	65	510	20
380	65	610	20
430	65	710	20
480	65	810	20
530	65	910	20

Cabide Extraível
Extractable Hanger

N66

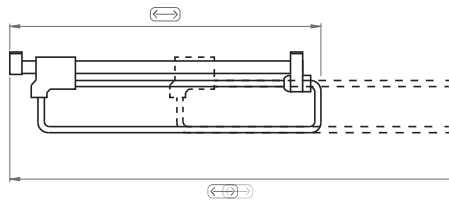

290	65	485	80
340	65	585	80

Cabide Duplo de Zamak
Zamak Double Hanger

012

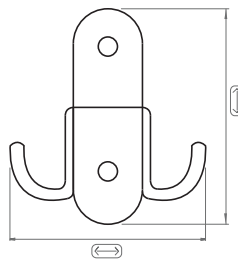

58,5	54	50

Acabamento: Nickel Mate
Finish: Matte Nickel

Cabide Simples Niquel Mate
Nickel Matte Simple Hanger

P22

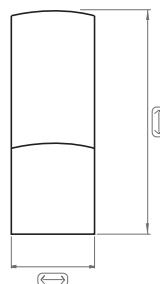

58,5	54	50

Acabamento: Nickel Mate
Finish: Matte Nickel

Cabide Duplo de Alumínio
Aluminium Double Hanger

K87.75

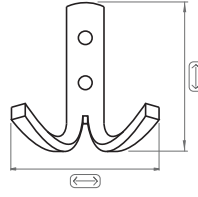

75	57	50

Acabamento: Anodizado Natural
Finish: Natural Anodized

Cabide Duplo de Alumínio
Aluminium Double Hanger

K87.19

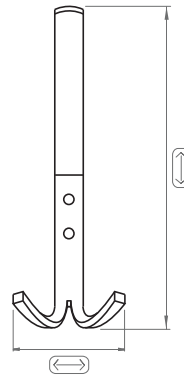

185	57	25

Acabamento: Anodizado Natural
Finish: Natural Anodized

Cabide Simples de Alumínio
Aluminium Simple Hanger

G29.75

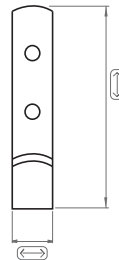

77	15.5	50

Acabamento: Anodizado Natural
Finish: Natural Anodized

Cabide Simples de Alumínio
Aluminium Simple Hanger

G29.19

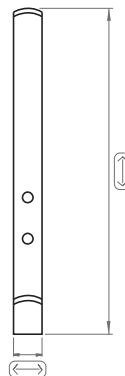

185	15.5	25

Acabamento: Anodizado Natural
Finish: Natural Anodized

Cabide Duplo de Zamak
Zamak Double Hanger

J05.12

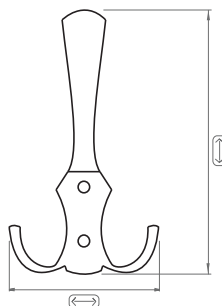

125	78,5	25

Acabamento: Nickel Mate
Finish : Matte Nickel

Cabide Duplo de Zamak
Zamak Double Hanger

J05.47

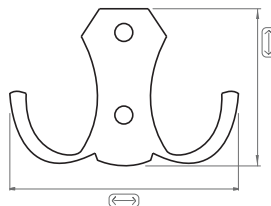

77,5	46	50

Acabamento: Nickel Mate
Finish : Matte Nickel





J

Pés e Rodízios Legs and Castors



Rodízio Industrial sem Travão
Industrial Castor without Brake

E74

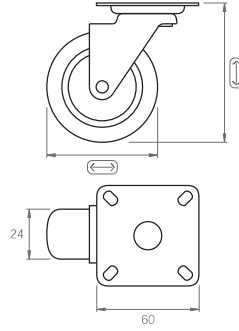

97	75	60

Rodízio Industrial com Travão
Industrial Castor with Brake

E75

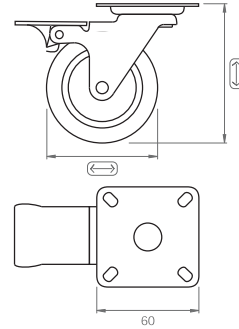

97	75	60

Rodízio Industrial sem Travão
Industrial Castor without Brake

E76

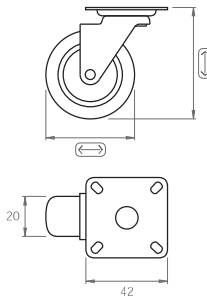

65	50	100

Rodízio Industrial com Travão
Industrial Castor with Brake

E77

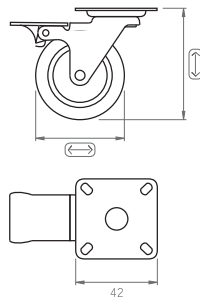

65	50	100

Rodízio de Alumínio sem Travão
Aluminium Castor without Brake

N84

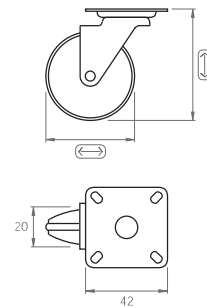

65	50	8

Rodízio de Alumínio com Travão
Aluminium Castor with Brake

N85

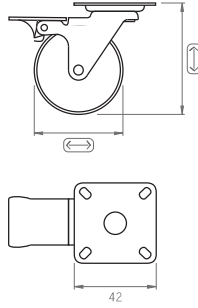

65	50	8

Rodízio de Alumínio sem Travão
Aluminium Castor without Brake

R50

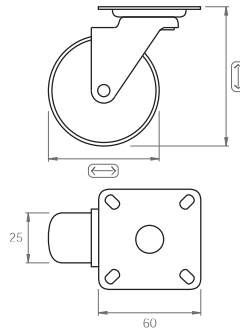

100	75	4

Rodízio de Alumínio com Travão
Aluminium Castor with Brake

N86

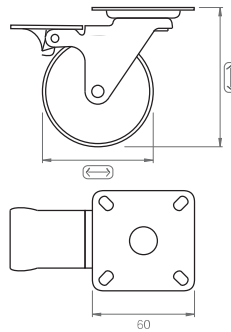

100	75	4

Rodízio de Alumínio sem Travão Transparente
Aluminium Castor without Brake Transparent

N87

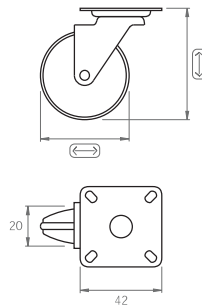

65	50	8

Rodízio de Alumínio com Travão Transparente
Aluminium Castor with Brake Transparent

N88

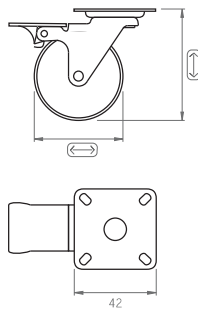

65	50	8

Rodízio Skate com e sem Travão
Skate Castor with or without Brake

L41

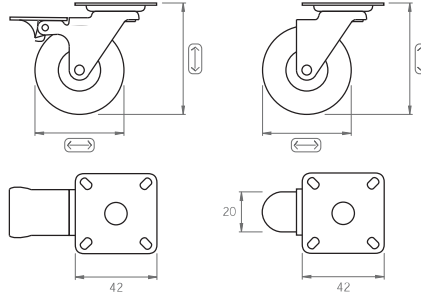

65	50	100

Rodízio Duplo
Double Castor

496

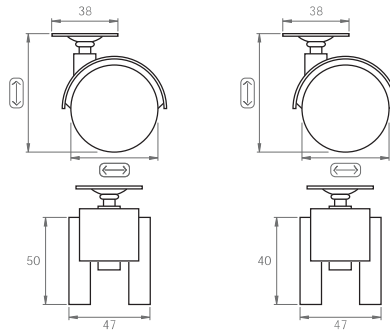

55	40	200
65	50	200

Rodízio Duplo com Travão
Double Castor with Brake

927

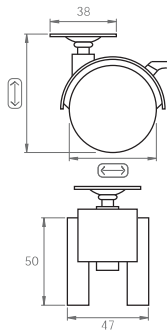

65	50	200

Rodízio Mini Plástico / Borracha
Plastic / Rubber Mini Castor

497



Plástico
Plastic

Borracha
Rubber

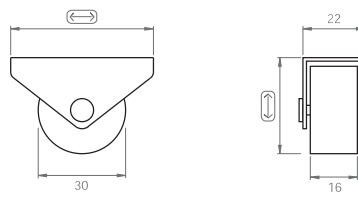

32	48	400

Rodízio Vertical Pottker
Pottker Vertical Castor

P93



Borracha
Rubber

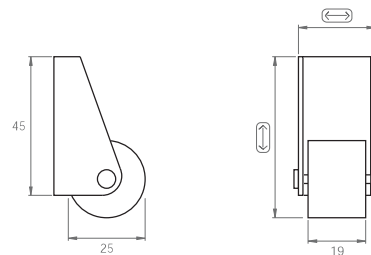

52	25	500

Rodízio Oculto
Embed Castor

L57

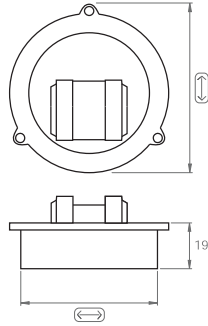

70	57	100

Pé Redondo de Alumínio Regulável
Adjustable Aluminium Round Leg

P01

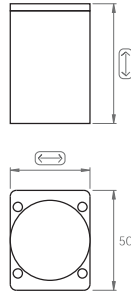

60	40	100

Acabamento: Anodizado Natural
Finish: Natural Anodized

Pé Quadrado de Alumínio Regulável
Adjustable Aluminium Square Leg

P02

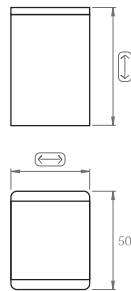

60	40	200
100	40	20
120	40	30
150	40	30

Acabamento: Anodizado Natural
Finish: Natural Anodized

Pé Quadrado de Alumínio
Aluminium Square Leg

P62

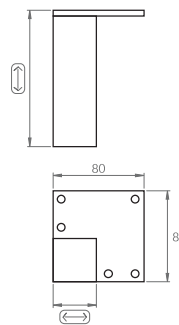
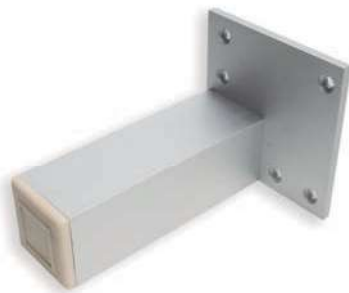

120	37	50
160	37	50
200	37	50

Acabamento: Anodizado Natural
Finish: Natural Anodized

Pé Quadrado de Alumínio/Plástico
Aluminium/Plastic Square Leg

K73

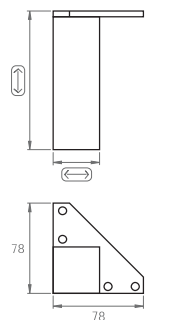

80	40	100
100	40	100
120	40	100
150	40	100

Acabamento: Anodizado Natural
Finish: Natural Anodized

Pé de Móvel Quadrado Zamak
Zamak Furniture Square Leg

J86

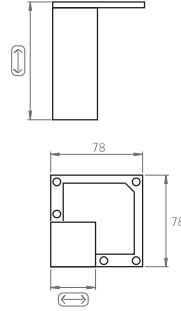

100	38	100

Acabamento: Nickel Mate
Finish: Matte Nickel

Pé de Móvel Regulável
Adjustable Furniture Leg

Q23

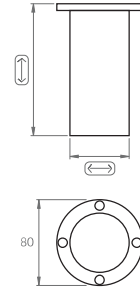

100	45	25
120	45	25
140	45	25

Acabamento: Nickel Satinado
Finish: Satin Nickel

Pé de Móvel
Furniture Leg

M99

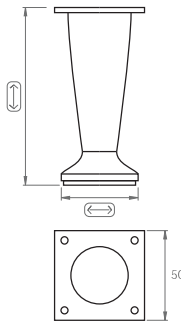

100	35	80

Acabamento: Nickel Satinado
Finish: Satin Nickel

Pé de Balcão Inclinado
Inclined Balcony Foot

N80

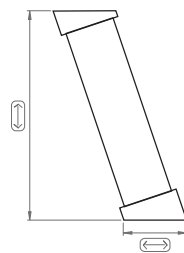

210	64	80

Acabamento: Nickel Satinado
Finish: Satin Nickel

Pé de Mesa
Table Leg

B70

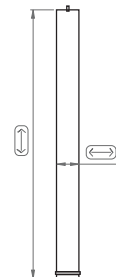

710	60	4
870	60	4

Acabamento: Nickel Satinado
Finish: Satin Nickel

Pé de Cozinha Plástico
Plastic Kitchen Leg

753

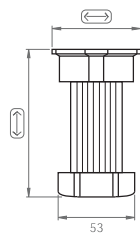

↑	↔	📦
100	55	200
120	55	180
150	55	150

Pé de Cozinha Plástico
Plastic Kitchen Leg

352

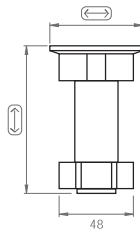

↑	↔	📦
100	60	200
120	60	180
150	60	150

Grampa para Pé de Cozinha P/ PVC
Panel Clip

589

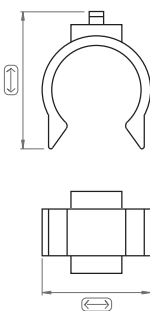

↑	↔	📦
47	36	1000

Grampa para Pé de Cozinha P/ Madeira
Panel Clip

757

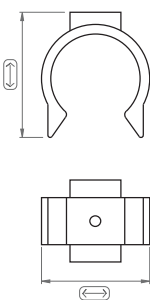

↑	↔	📦
41	36	1000

Grampa para Pé de Cozinha P/ PVC
Panel Clip

588.112

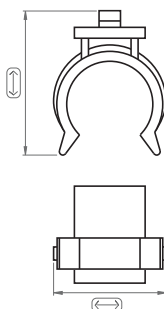

↑	↔	📦
35,5	32,3	1000

Grampa Metálica p/Pé de Cozinha
Metalic Panel Clip

588.102

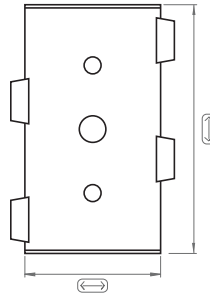

55	30	1000

Pé Nivelador
Leveler Leg

Q16

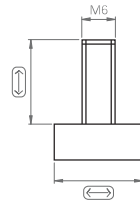

14	16	1500

Pé Nivelador
Leveler Leg

Q17

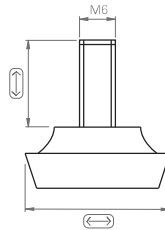

14	24	700

Pé Nivelador
Leveler Leg

Q18

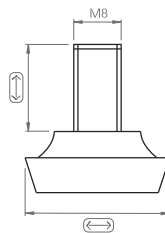

15	24	700

Nivelador Bomboca
Adjustable Leg

D99

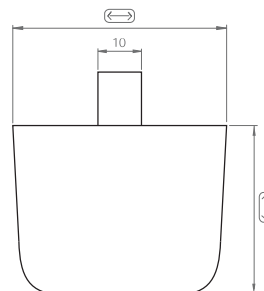

38.7	48.5	250

Nivelador de Aparafusar Invisível
Invisible Bolt Leveller

F04

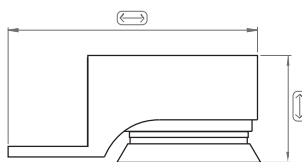

21.7	49	250

Deslizador c/Feltro
Slipper w/Felt

B63

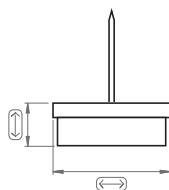

7	24	1000

Deslizador de Agrafar
Stapling Slipper

150



15	54	1000

Cores:
Colors: ● ○

Deslizador de Agrafar c/Bucha
Stapling Slipper w/Dowel

151

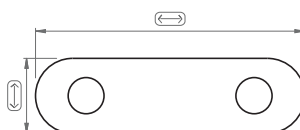

15	54	1000

Cores:
Colors: ● ○

Deslizador c/Prego
Slipper w/Nail

F09

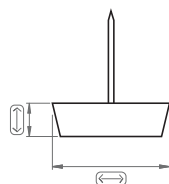

			Cores: Colors:
4	15	1000	● ○
5	20	1000	○
5.4	22	1000	○
6	25	1000	○

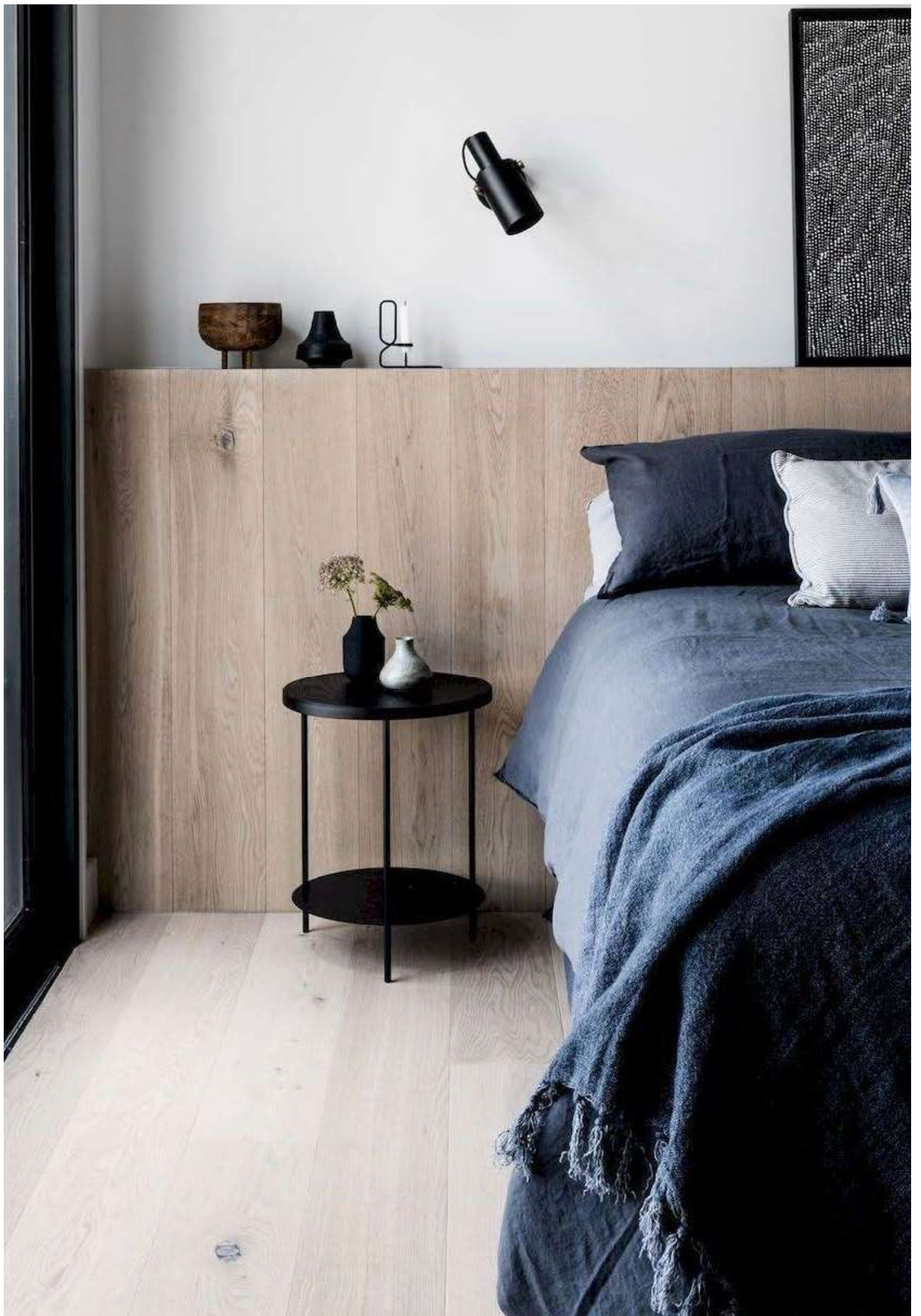

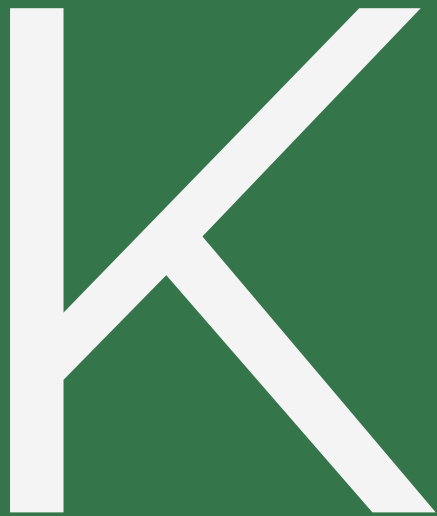

Sistemas de Ligação
Connection Systems



Ligador de Encaixe
Housing Connector

718

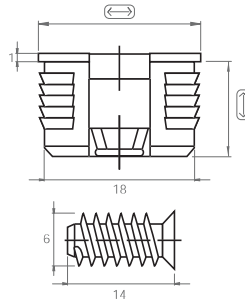

13	21	1000

Ligador c/Minifixo + Paraf. Rosca Madeira
Housing Connector + Screw

816

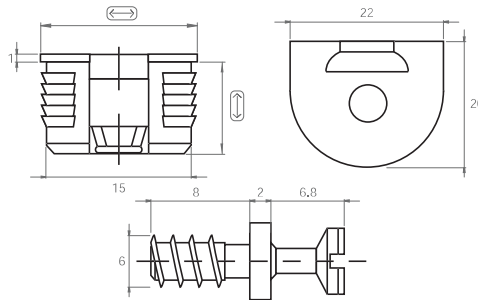

14,5	20	1000

Ligador Uniblock
Uniblock Connector

E32

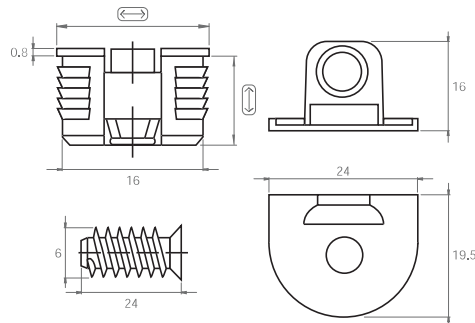

13	20	2000

Ligador Tris
Tris Connector

G74

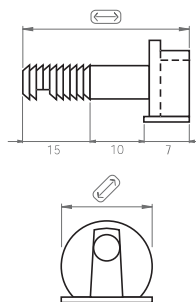

20	32	1000

Ligador a 90°
90° Connector

F28

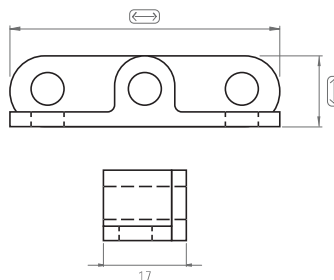

14	40	500

Acabamento: Zincado / Passivado Amare.
Finish: Zinc Plated / Yellow Passivated

K

Ligador a 90°
90° Connector

R31

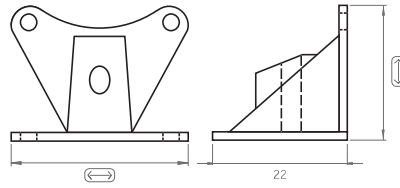

23	35	1000

Copo Ligador Alta Segurança
High Security Connector Cup

985.35

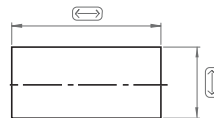

16,8	35	100

Perno Ligador Alta Segurança
High Security Connector Dowel

985

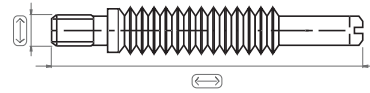

10	85	100
10	65	100

Copo de Ligador JL
JL Connector Cam

P66

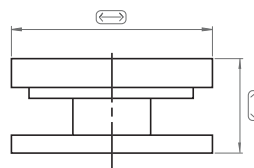

16,5	35	500

Perno de Ligador JL
JL Connector Dowel

P67

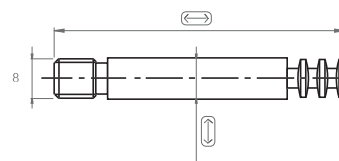

8,5	59	500

K

Paraf. de Cama c/Arco Rasgado
Bed Screw w/Torn Arc

599

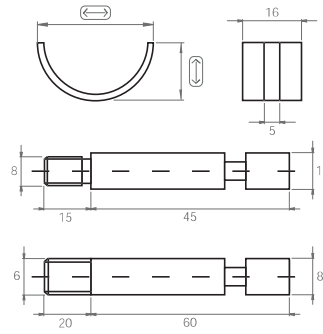

16	34	250

Caixa de Ligador Minifixo
Minifix Connector Cam

586

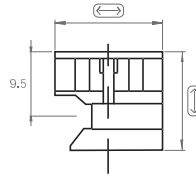

13.9	15	2000

Caixa de Ligador Minifixo
Minifix Connector Cam

585

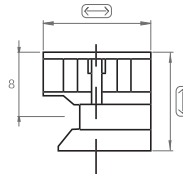

12.5	15	2000

Perno de Ligador Minifixo
Minifix Connector Dowel

711

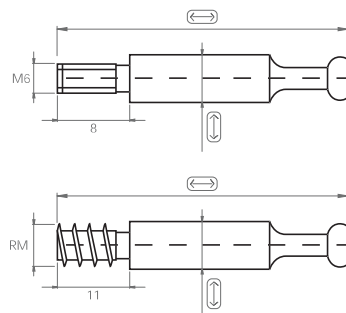

7	42	2000
7	45	2000

Tapa para Cobrir Ligador Minifixo
Minifix Connector Cover

712

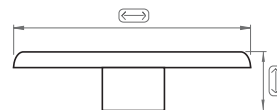

4	16.5	2000

K

Copo de Ligador sem Bordo
Connector Cam without Edge

D72.08

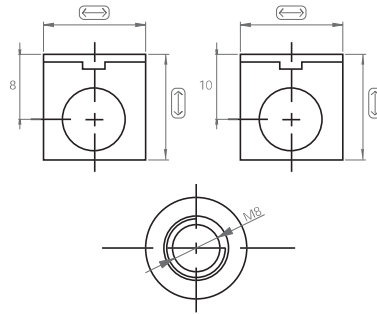

13,5	14	2000
15,5	14	2000

Copo de Ligador com Bordo
Connector Cam with Edge

D72.10

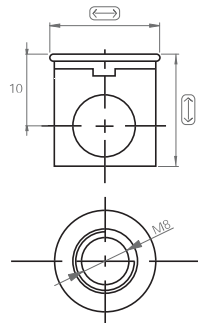

16,5	15,5	2000

Copo de Ligador sem Bordo
Connector Cam without Edge

G58

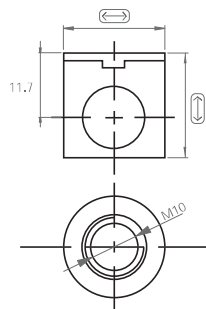

19,3	16	1000

Perno para Ligador
Connector Dowel

D74

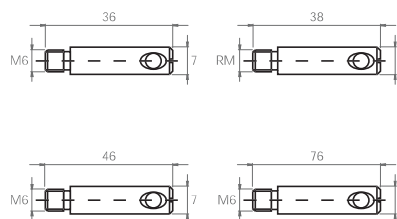

1000

Perno para Ligador
Connector Dowel

D75

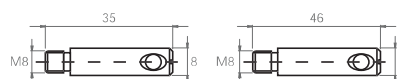

2000

K

Perno para Ligador
Connector Dowel

M48

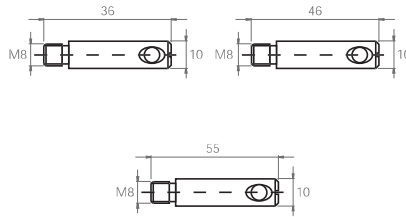

Perno Duplo para Ligador
Connector Double Dowel

709

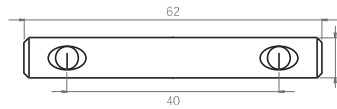

Perno a 90° para Ligador
90° Connector Dowel

D74.75

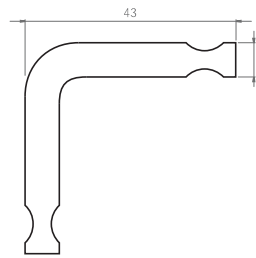

Perno Articulado para Ligador
Articulated Connector Dowel

D74.VT

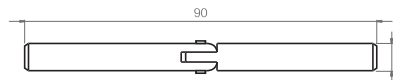

Espigão de Aperto para Ligador
Connector Screw

D76

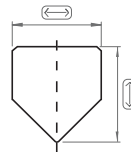

↕	↔	📦
8	M6	10000
11	M8	10000
13.5	M10	5000

Copo de Ligador
Connector Cam

824

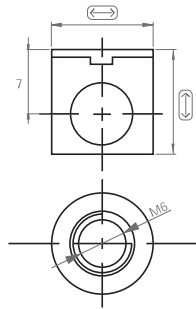

13	10	2500

Semfim M6
M6 Insert

594

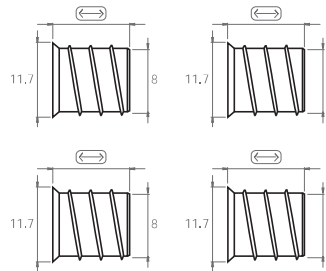

13	4000
15	3000
20	2000
24	2000

Semfim M8
M8 Insert

874

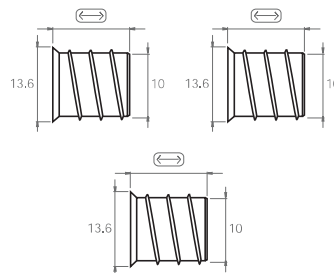

15	4000
20	3000
24	2000

Semfim M10
M10 Insert

C26

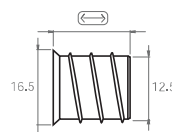

20	1000

Semfim M6 com Rasgo
M6 Insert with Slit

502

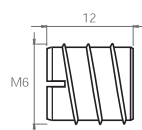

2000

K

Bucha c/Rosca
Dowel w/Thread

608

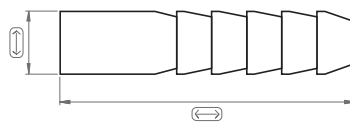

6	30	1000
8	30	1000

Bucha Nylon Auto Roscante
Self-Threading Nylon Dowel

E10

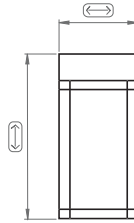

9,5	5	10000

Bucha para Dobradiça
Hinge Dowel

C87

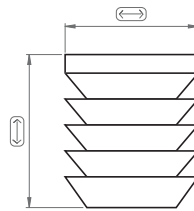

13	10	1000

Bucha Nylon
Nylon Dowel

050

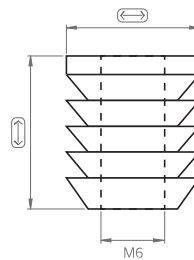

12,5	10	10000

Ligador Zamak Excêntrico
Excentric Zamak Connector

N73

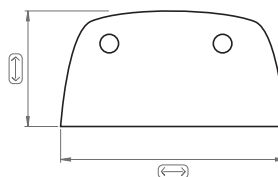

39	25	27,8

K

Parafuso de Aglomerado
Agglomerate Screw

257

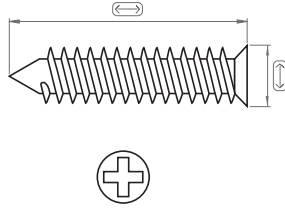

	12	16	18	20	25	30	35	40	45	50	55	60	70
2,5		✓											
3	✓	✓	✓	✓	✓	✓	✓						
3,5	✓	✓	✓	✓	✓	✓	✓	✓	✓	✓			
4	✓	✓	✓	✓	✓	✓	✓	✓	✓	✓	✓	✓	
4,5		✓	✓	✓	✓	✓	✓	✓	✓	✓	✓	✓	✓
5						✓	✓	✓		✓	✓	✓	✓
6													✓

Parafuso de Cabeça Chata
Flat Head Screw

265

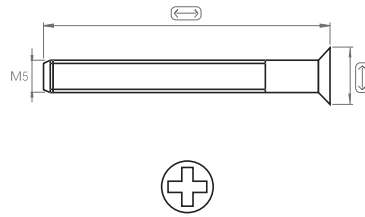

7	55	500

Parafuso M4 de Cabeça Oval
M4 Oval Head Screw

263

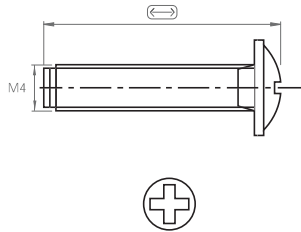

10	27	1000
12	30	
14	35	
20	38	
22	40	
25	45	

Parafuso Ligador
Connector Screw

299

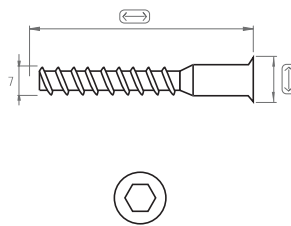

8	50	1000

Parafuso Ligador
Connector Screw

300

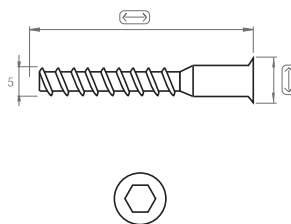

7,5	50	1000

K

Parafuso Cabeça Oval
Oval Head Screw

262

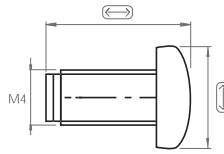

↕	↔	📦
17	8	2000
17	9	2000



Parafuso Sextavado
Hexagonal Screw

H93

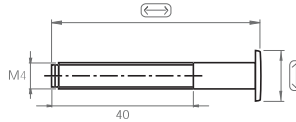

↕	↔	📦
17	50	1400
17	70	1000



Parafuso com Ligador
Connector with Screw

747

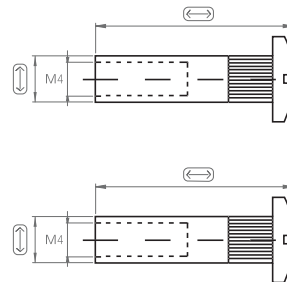

↕	↔	📦
5	15	5000
5	29	2000



Parafuso de Ligação D.José
D.José Connector Screw

260

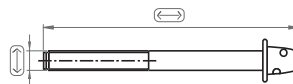
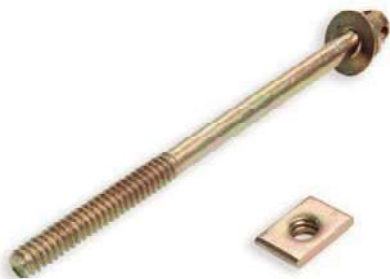

↕	↔	📦
M8	55	120
M8	65	120
M8	80	120
M8	100	120
M8	134	120

Porca de Ferro M6
M6 Steel Nut

867

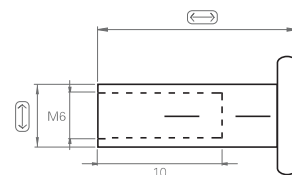

↕	↔	📦
8	14	3000



Batente c/Rosca Central M6
M6 Threaded Stop

060

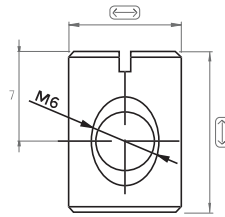

14	10	1000

Batente c/Rosca Descentrica M6
M6 Descent. Threaded Stop

698

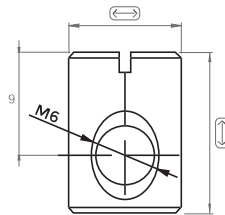

14	10	1000

Batente c/Rosca Descentrica M5
M5 Descent. Threaded Stop

061

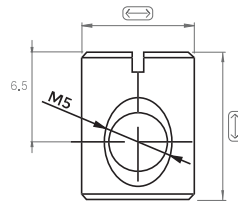

12	10	1000

Haste Roscada
Threaded Rod

209

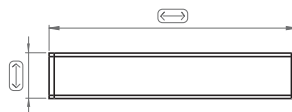

M6	20	100
M6	26	100
M6	33	100
M6	40	100
M6	45	100
M6	50	100
M6	60	100
M6	80	100
M6	85	100

Parafuso Euro p/Furo 5 mm
5 mm Hole Euro Screw

E82

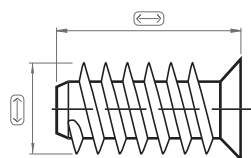

6	24	1000



K

Esquadro Plástico
Plastic Bracket

L13

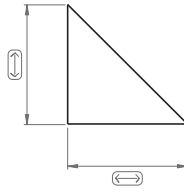

11	11	1000

Cores:
Colors: ● ○

Chapa Quadrada 4 Furos
4 Holes Square plate

583

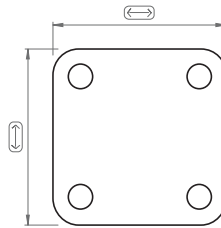

37	37	1000

Esquadro de Ferro Grande
Big Steel Square

165

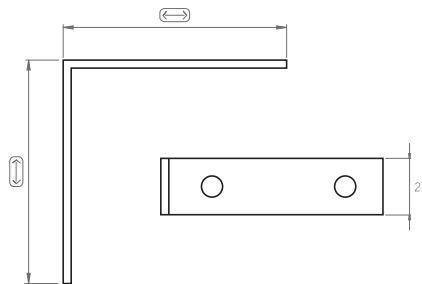

55	55	500

Esquadro 3 Furos + Rasgo
3 Holes Square + Tear

748

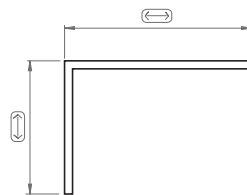

26	30	500

Esquadro Plano 4 Furos
4 Holes Flat Square

B81

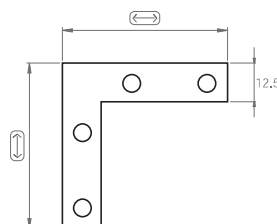

60	60	750

Esquadro 4 Furos
4 Holes Square

K45

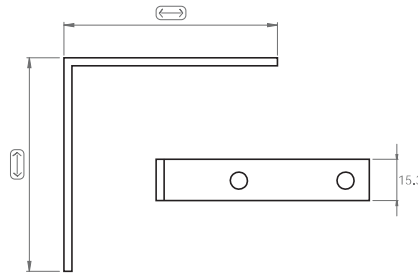

30	30	500
40	40	500
50	50	500
60	60	500

Esquadro 4 Furos
4 Holes Square

166

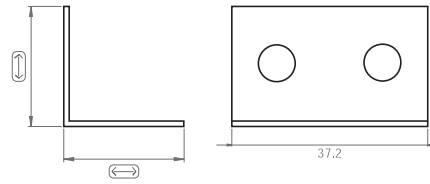

20	20	1000

Esquadro 2 Furos
2 Holes Square

632

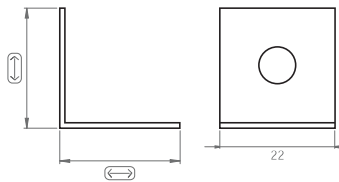

24	24	1500

Chapa de Ligação Plano
Flat Connector Plate

B62

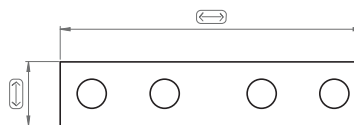

15.3	60	1000

Esquadro Plástico com Tapa
Plastic Square with Cover

379

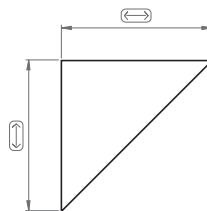

22	22	500

Cores Colors		
Branco Walnut	Pinho Pine	Cinza Grey
Castanho Briarum	Carvalho Oak	

K

Esquadro Metálico
Metalic Square

N95

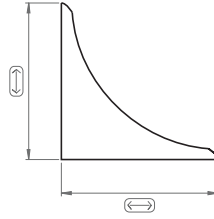

18	18	2000

Tranqueiro de Cama
Bed Coupling

155

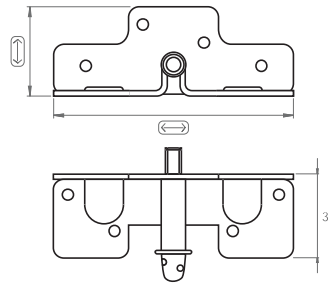

36	96.6	150

Tranqueiro de Cama
Bed Coupling

670

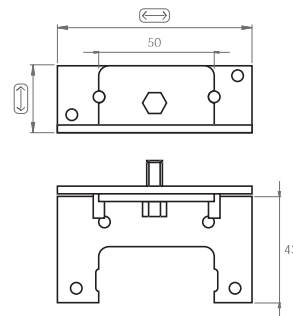

26	83	150

Tranqueiro de Cama
Bed Coupling

535

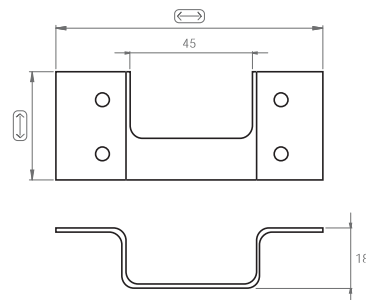

33.5	93	500

Tranqueiro de Cama
Bed Coupling

156

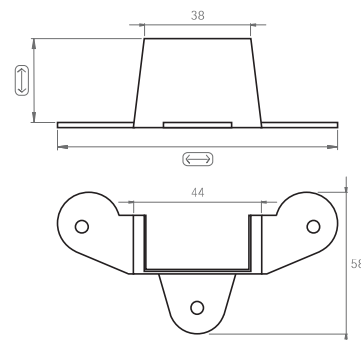

30	97	500

Canto de Ligação
Corner Connector

L61

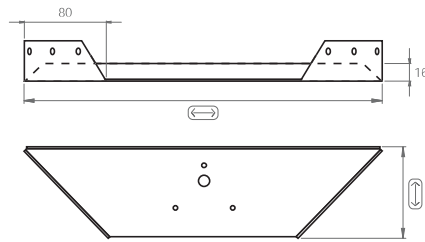

75	300	60

Chapa de Ligação Plana
Flat Connector Plate

877

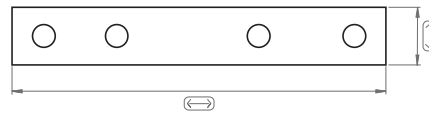

20	130	500

Cavilha de Madeira Faia
Beech Wood Pin

112

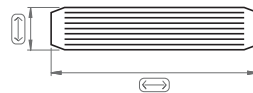

20 Kg

	20	25	30	35	40	45	50	60	1M
6	✓	✓	✓	✓	✓	✓	✓		
8	✓	✓	✓	✓	✓	✓	✓		✓
10	✓	✓	✓	✓	✓	✓	✓	✓	✓

Lamela de Madeira
Wood Lamella

R24

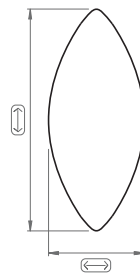

54	24	1000

Escapula Fendada
Cracked Scapula

E63

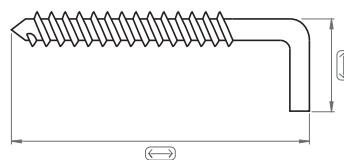

16,5	53,4	250

Parafuso p/ Ligador 718
718 Connector Screw

G31

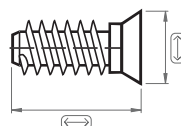

10	13	250

K





Compassos Lifting Systems



Compasso Top Stays
Top Stays Lifting System

S69

P	
500-1500	20
960-2350	20

P = altura (mm) x peso
P = height (mm) x weight

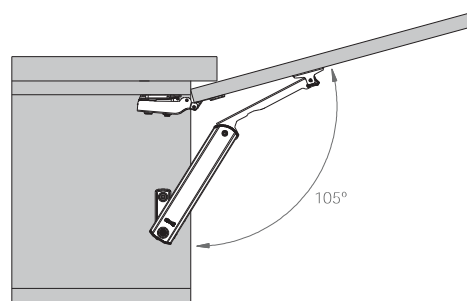
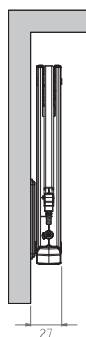
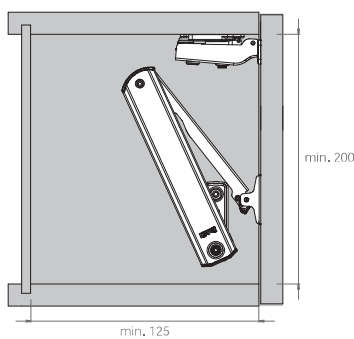

L

R72



P	Box Icon	Cores:
580-1250	10	● ○
960-2040	10	● ○
1800-3500	10	● ○
3200-9000	10	●

P = altura (mm) x peso
P = height (mm) x weight

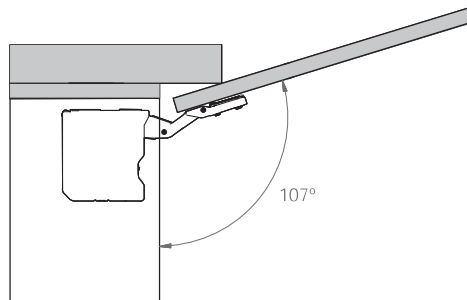
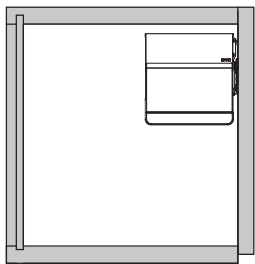

S67
Limitador de 75°
75° Restriction Clip



Compasso Top Stays
Top Stays Lifting System

S78

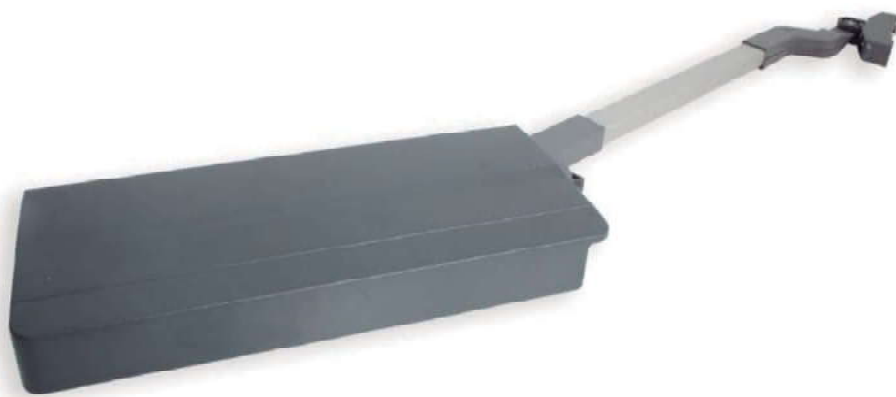

P	
500-1500	20

P = altura (mm) x peso
P = height (mm) x weight

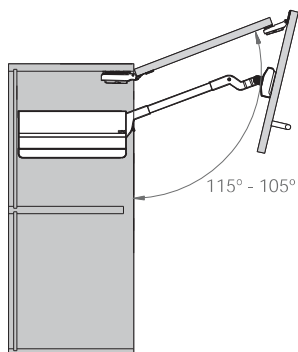
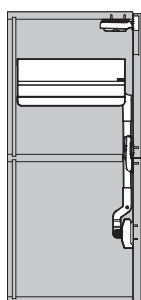

L

Compasso a Gás de Levantar
Gas Compass to go Up

N64

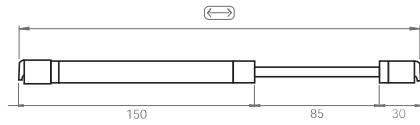

N	↔	📦
5	265	100
8	265	100
12	265	100

Compasso a Gás de Descair
Gas Compass to go Down

N63

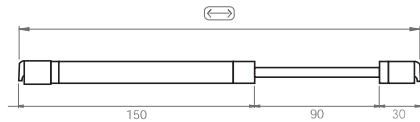

N	↔	📦
8	270	100
15	270	100

Compasso Soft
Soft Compass

L78

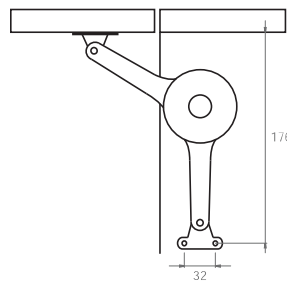

📦
10

Compasso p/Elevar Portas Esq. / Dir.
Left / Right Compass for Lifting Doors

G81

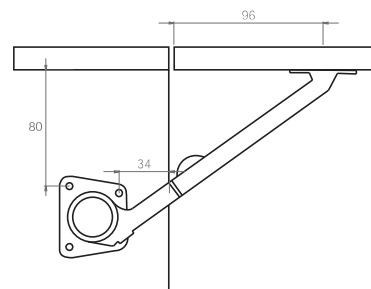

📦
1

Compasso de Tacão
Compass

600

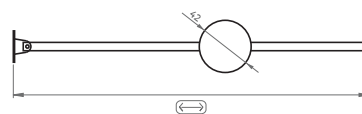

↔	📦
245	100

Cores:
Colors: ● ○

Compasso p/Elevar Portas
Compass for Lifting Door

939

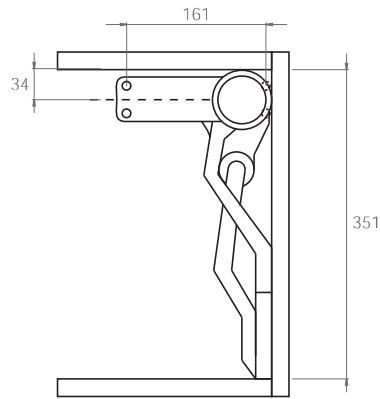
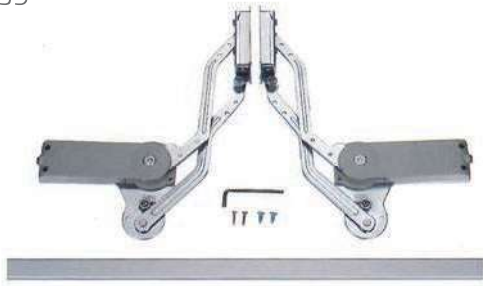

Compasso para Sommier
Sommier Compass

R33

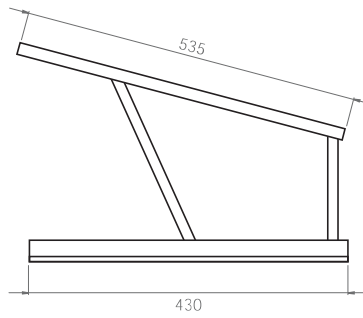

Compasso para Sommier
Sommier Compass

R34

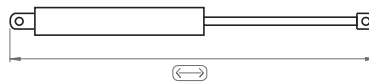

N	↔	📦
1150	350	1
1500	350	1

Estrutura de Cama Sommier
Sommier Bed Structure

L69

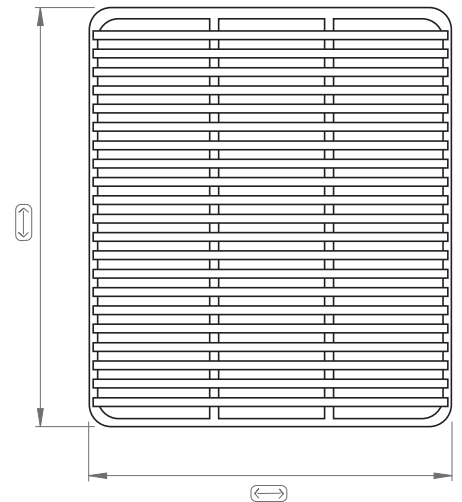

📏	80	88	90	94	95	98	100	118	123	128	130	133	135	137	140	150	160	180
183	✓	✓		✓		✓		✓	✓	✓	✓	✓						
190			✓		✓								✓	✓	✓	✓		
195					✓										✓	✓	✓	
200							✓									✓	✓	✓

S74

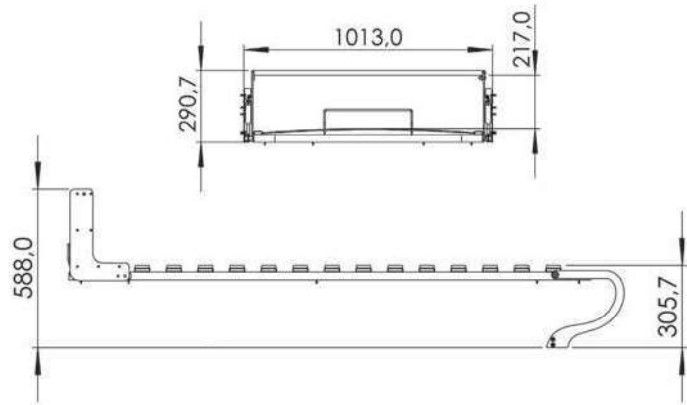
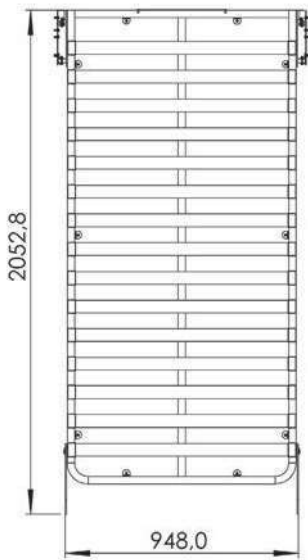
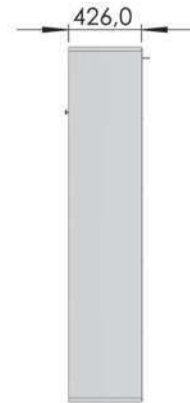
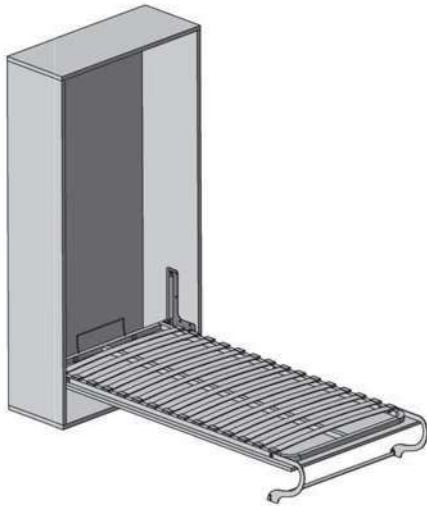



M

Suportes de Prateleira Shelf Support



Suporte de Prateleira Pelicano
Wall Shelf Support

K20

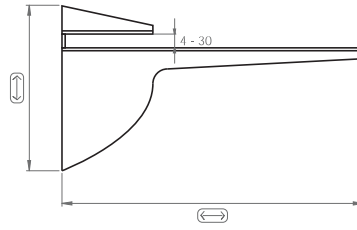

65-95	130	25

Acabamento: Satinado / Crom, Brilho
Finish: Satin / Bright Chrome

Suporte Prateleira Pelicano
Wall Shelf Support

D41

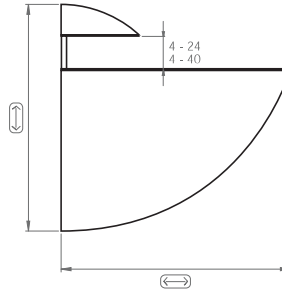

55-79	52	100
85-125	102	10

Acabamento: Nickel Mate
Finish: Matte Nickel

Suporte Prateleira Pelicano
Wall Shelf Support

N28

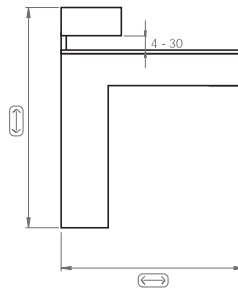

84-114	68	12

Acabamento: Nickel Mate / Satinado
Finish: Matte Nickel / Satin

Suporte Prateleira Pelicano
Wall Shelf Support

N29

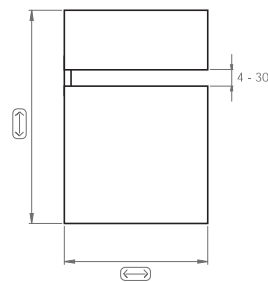

55-85	40	100

Acabamento: Nickel Mate / Satinado
Finish: Matte Nickel / Satin

Suporte Prateleira Pelicano
Wall Shelf Support

N65

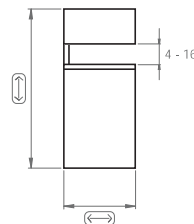

46-62	16	100

Acabamento: Nickel Mate / Satinado
Finish: Matte Nickel / Satin

M

Suporte de Prateleira Invisível
Invisible Shelf Support

F26



10	120	100
10	170	100

Suporte de Prateleira Invisível
Invisible Shelf Support

949



10	120	100

Suporte Prateleira de Vidro
Glass Shelf Support

B65

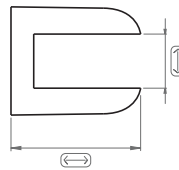

6	24	600
10	24	50

Acabamento: Cromado Mate
Finish: Matte Chrome

Suporte Prateleira de Vidro
Glass Shelf Support

B66

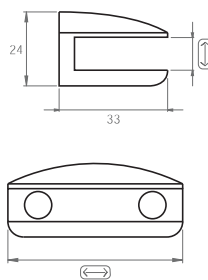

8	48	100
10	48	100

Acabamento: Níquel Mate
Finish: Matte Nickel

Suporte Prateleira de Vidro
Glass Shelf Support

K31

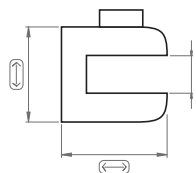

14	14	1000

Acabamento: Níquelado
Finish: Nickel Plated

Suporte de Prateleira de Vidro Ajustável
Glass Shelf Adjustable Support

R78

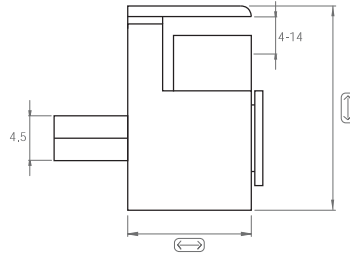

20.5	12.4	100

Suporte de Prateleira de Vidro Ajustável
Glass Shelf Adjustable Support

D51

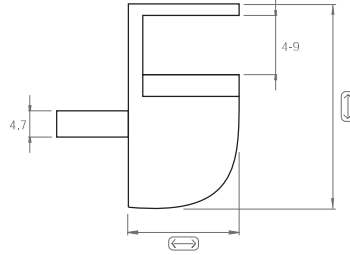

20.5	12.4	100

Suporte Prateleira c/2 Pernos
Shelf Support w/2 Pins

825

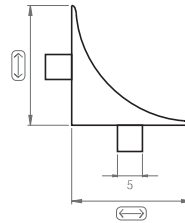

13	13.5	2500

Suporte Prateleira c/1 Perno
Shelf Support w/1 Pin

E13

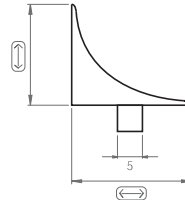

13	13.5	2500

Suporte Prateleira de Vidro
Glass Shelf Support

B71

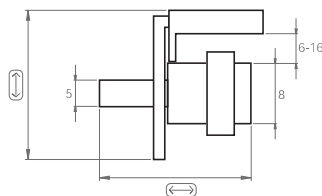

20-30	20	1000

Suporte Prateleira de Vidro c/Anel Morbido
Glass Shelf Support w/Morbid Ring

C94

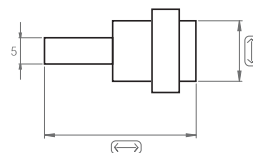

14	14	1000

M

Suporte Prateleira c/Ventosa
Shelf Support w/Suction Cup

510/A17

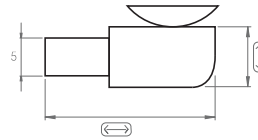

8,5	23	1000

Patilha Dupla 5 MM
5 MM Double Pin

358

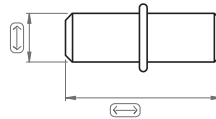

5	16	5000

Patilha c/Proteção para Vidro
Lever w/Glass Protection

F02

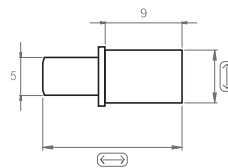

7	17	1000

Suporte Prateleira c/2 O-Rings
Glass Shelf Support w/2 O-Rings

826

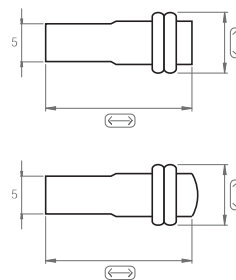

8	19	5000

Acabamento: Zincado / Oxidado
Finish: Galvanized / Oxidized

Suporte de Embutir c/ Patilha
Embed Support w/Lever

R35

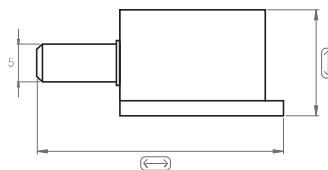

14	31,5	250

Suporte Prateleira Plástico
Plastic Shelf Support

508

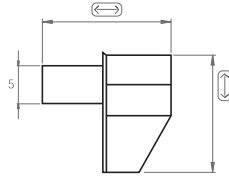

15,5	17	1000

Acabamento: Transp. / Branco / Cast.
Finish : Transp. / White / Brown

Suporte de Prateleira c/Prego
Shelf Support w/Nail

511

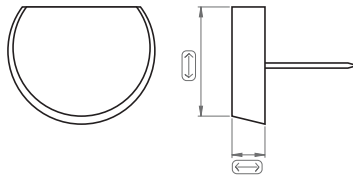

13	4,4	1000

Acabamento: Branco / Cast.
Finish : White / Brown

Patilha de Ferro
Iron Pin

359

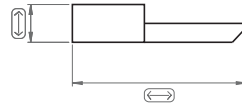

7	22	1000

Acabamento: Niquelado / Latonado
Finish : Nickel Plated / Brass

Ilhós Metálico
Metalic Eyelet

210

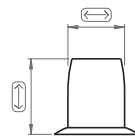

10	7,5	1000

Acabamento: Niquelado / Latonado
Finish : Nickel Plated / Brass

Suporte de Moldura de Embutir Zamak
Zamak Embed Frame Support

046

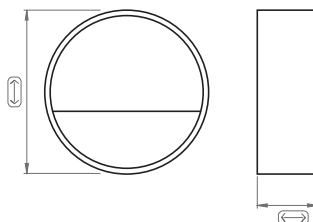

30	11	1000

Suporte de Moldura de Embutir Plástico
Plastic Embed Frame Support

988

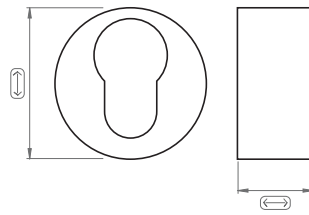

20	10	1000

Suporte de Espelho Triangular
Triangular Mirror Support

111

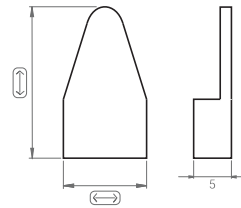

20	11	1000

Suporte de Enganchar p/Moldura
Frame Support

948

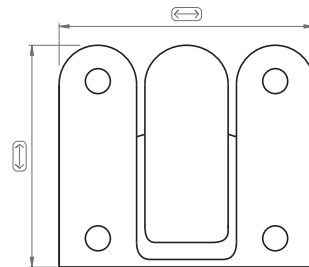

40	46	1000

Suporte de Móvel
Furniture Support

516

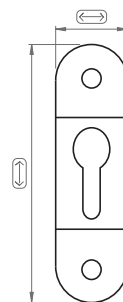

60	24	1000

Suporte de Móvel
Furniture Support

517

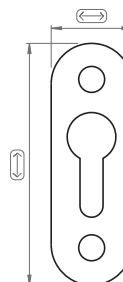

42	14	1000

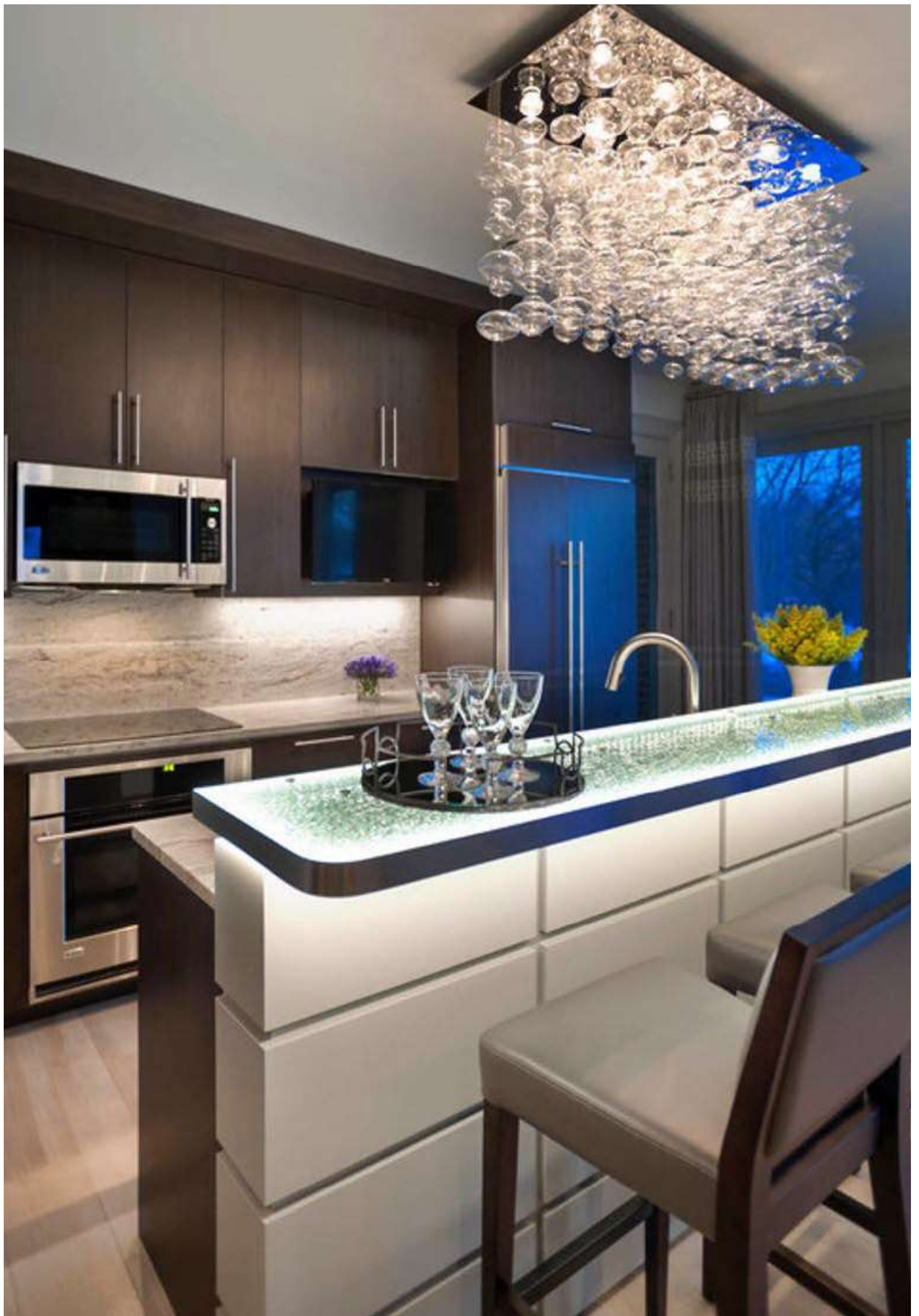

N

Fechos e Fechaduras
Locks and Latches



Fecho Push Forte c/Magnético
Push to Open Strong Lock w/Magnetic

R19

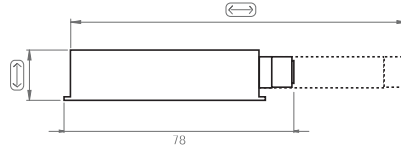

20	117	100

Cores:
Colors: ● ●

Fecho Push Forte c/Borracha
Push to Open Strong Lock w/Rubber

R20

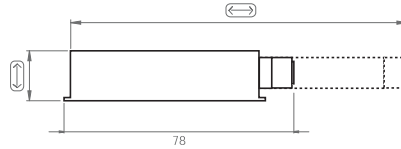

20	117	100

Cores:
Colors: ●

Fecho Push de Embutir c/Magnético
Embed Push to Open Lock w/Magnetic

R21

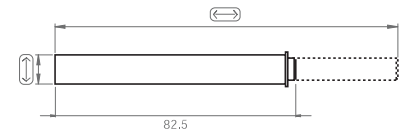

10	117.5	100

Cores:
Colors: ●

Fecho Push de Embutir c/Borracha
Embed Push to Open Lock w/Rubber

R22



10	117.5	100

Cores:
Colors: ●

Fecho Push Forte c/Borracha
Push to Open Strong Lock w/Rubber

Q89

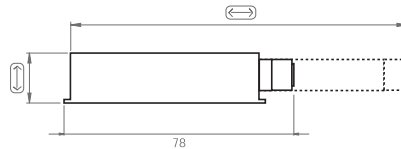

20	120	100

Cores:
Colors: ●



Fecho Push Forte c/Borracha
Push to Open Strong Lock w/Rubber

S09

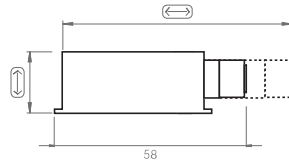

20	70	100

Cores: ●
Colors:

Fecho Push Forte c/Magnético
Push to Open Strong Lock w/Magnetic

S10

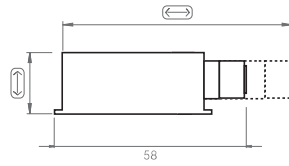

20	70	100

Cores: ●
Colors:

Fecho Push Big c/Magnético
Push to Open Big Lock w/Magnetic

S36

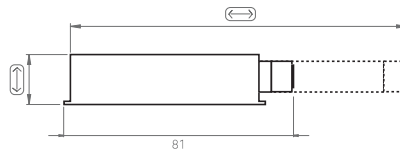
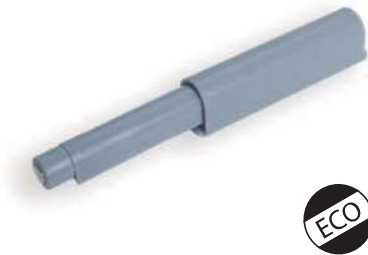

20	120	100

Cores: ●
Colors:

Fecho Push c/Borracha
Push to Open Lock w/Rubber

O18

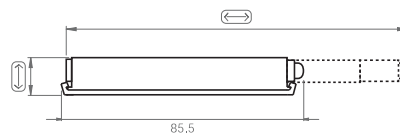

14,3	125,5	1000

Cores: ● ○
Colors:

Fecho Push c/Magnético
Push to Open Lock w/Magnetic

O19

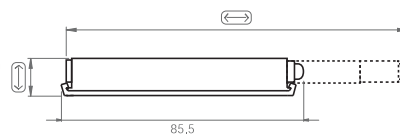
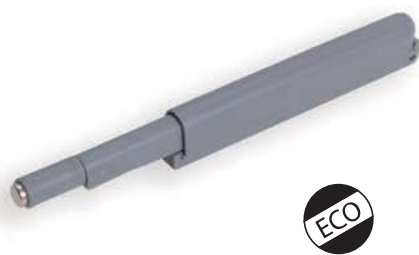

14,3	125,5	1000

Cores: ● ○ ● ●
Colors:

N

Fecho Push Flat c/Borracha
Push to Open Flat Lock w/Rubber

S06

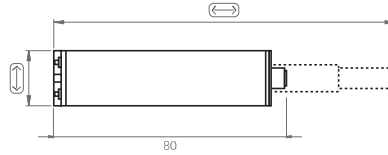

20.5	120	100

Fecho Push Flat c/Magnético
Push to Open Flat Lock w/Magnetic

S07

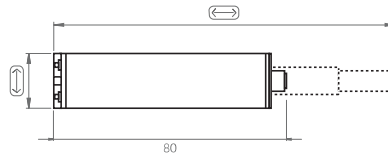

20.5	120	100

Chapa p/ Fecho Magnético
Magnetic Lock Plate

O53

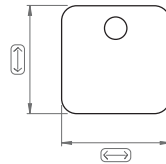

20	20	100

Anilha Ferro p/Magnético
Steel Washer to Magnetic Lock

D47

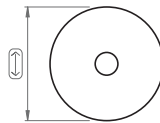

15	1000

Fecho Magnético
Magnetic Lock

204

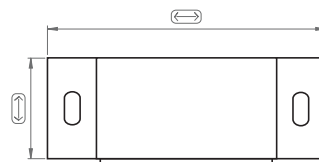

16.5	45.5	100

Cores:
Colors: ● ○

Chapa de Magnético
Magnetic Plate

069

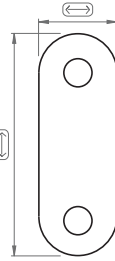

45.2	12.7	1000

Fecho de Mesa c/ Mola Castanho
Brown Table Lock w/String

L40

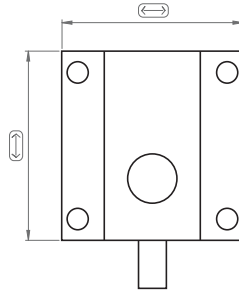

24	23	1000

Fecho Magnético Big
Big Magnetic Lock

E56

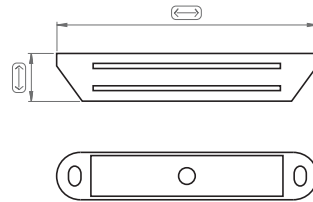

8.5	46.5	1000

Fecho Linguete c/ Mola Segurança
Latch Lock w/ Security Spring

G30

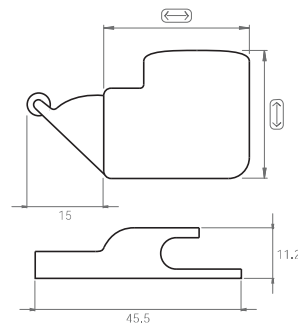

28.3	32.5	1000

Fecho Alavanca
Lever Lock

704

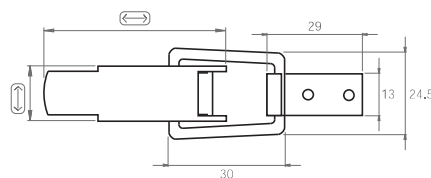

17.5	62	100

Acabamento: Zincado
Finish: Zinc Plated

Fecho Alavanca Grande Passivado Amarelo
Yellow Passivated Big Lever Lock

Q61

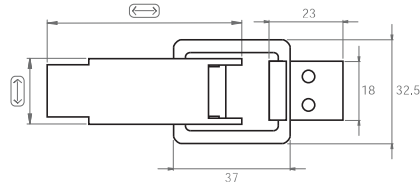

20	62	100

Fecho Magnético 7Kg Castanho
7Kg Brown Magnetic Lock

634

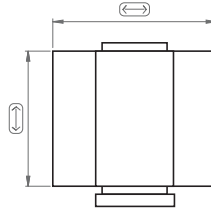

24	29	1000

Fecho de Esferas Niquelado
Nickel Plated Spheres Lock

960

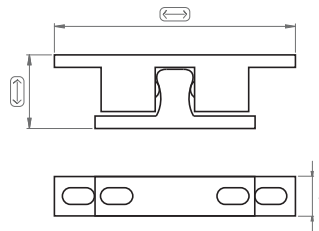

15.5	50	100

Fecho Metálico Niquelado
Nickel Plated Metallic Lock

R79

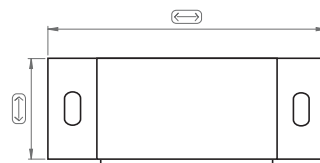

21	48	100

Fechadura Cromado c/Linguetas
Pawf Chrome Door Lock

290

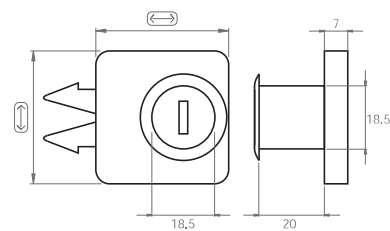

40	40	240

Fechadura de Porta de Vidro Cromado
Chrome Glass Door Lock

N23

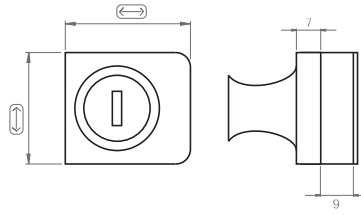

32	36	160

Fechadura Cromado
Chrome Door Lock

N22

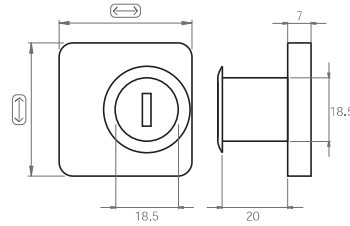

40	40	240

Fechadura Cromado de Serrilha
Chrome Door Lock

N21

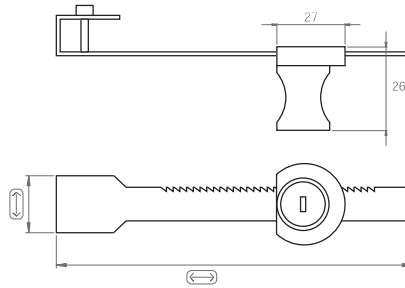

23	145	240

Batente de Fechadura Niquelado
Nickel Plated Locker Stopper

048

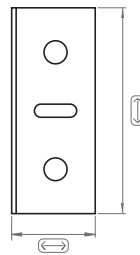

33	13,4	1000

Fechadura de Inox Redonda Satinado
Satin Stainless Steel Round Lock

S28

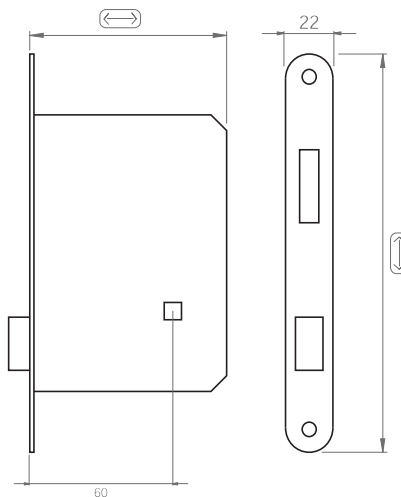

180	89	1

Fechadura de Inox Quadrada Satinado
Satin Stainless Steel Square Lock

S29

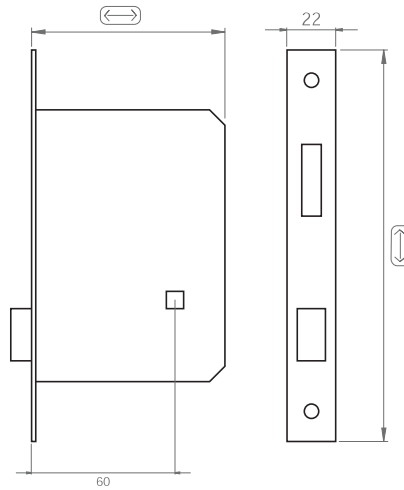
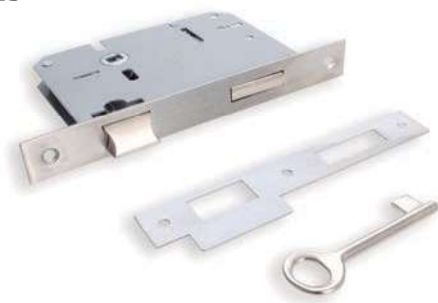

180	89	1



N



Asas e Puxadores
Handles and Knobs



Asa de Zamak
Zamak Handle

S76

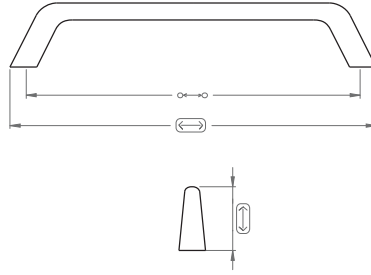

128	140	30	25
160	172	30	25

Acabamento: Satinado
Finish : Satin

Asa de Zamak
Zamak Handle

S77

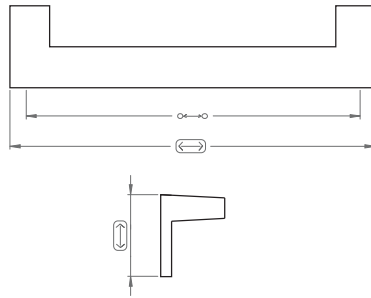

128	143	32	25

Acabamento: Cromado Brilhante
Finish : Bright Chrome

Asa de Zamak
Zamak Handle

S80

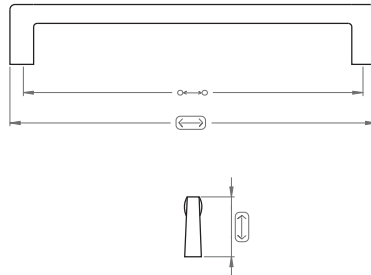

128	140	28	25
160	172	28	25
256	268	28	25

Acabamento: Satinado
Finish : Satin

Asa de Alumínio
Aluminium Handle

S81

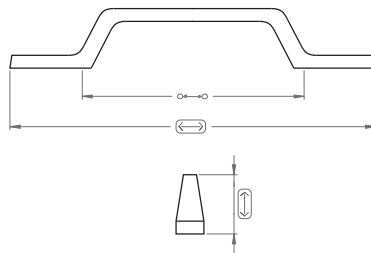

128	192	26.5	25
160	224	26.5	25
192	256	26.5	25
224	320	26.5	25
256	384	26.5	25
320	448	26.5	25

Acabamento: Satinado
Finish : Satin

Asa de Zamak
Zamak Handle

Q36

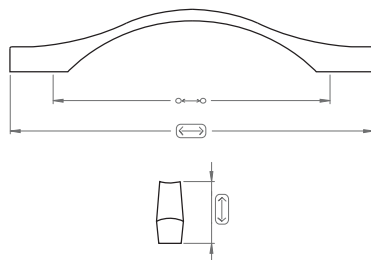

128	164	28	25
160	196	30	25
256	292	30	25

Acabamento: Satinado
Finish : Satin

Asa de Zamak
Zamak Handle

S70

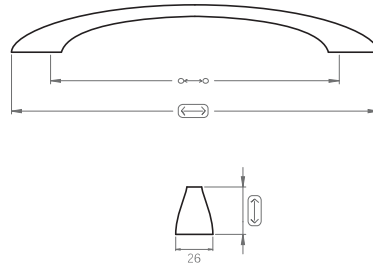

192	247	32	20

Acabamento: Satinado
Finish: Satin

Asa de Zamak
Zamak Handle

S71

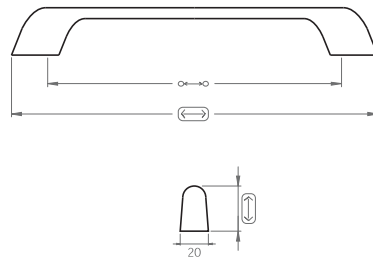

192	247	32	20

Acabamento: Satinado
Finish: Satin

Asa de Zamak
Zamak Handle

S72

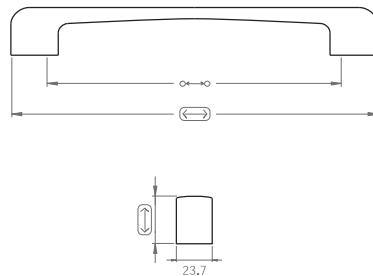

192	247	32	20

Acabamento: Cromado Mate
Finish: Matte Chrome

Asa de Alumínio
Aluminium Handle

S73

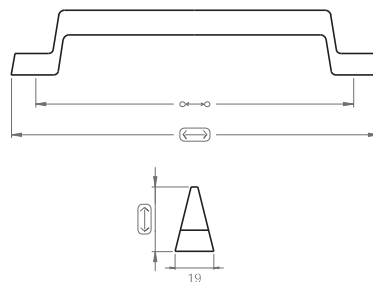

160	180	31	20

Acabamento: Satinado Champanhe
Finish: Champagne Satin

Asa de Alumínio
Aluminium Handle

S08

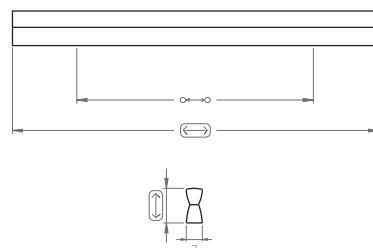

168	96	15,2	20
200	128	15,2	20
232	160	15,2	20
264	192	15,2	20
294	224	15,2	20

Acabamento: Cromado Brilho
Finish: Bright Chrome

Asa de Alumínio
Aluminium Handle

Q33

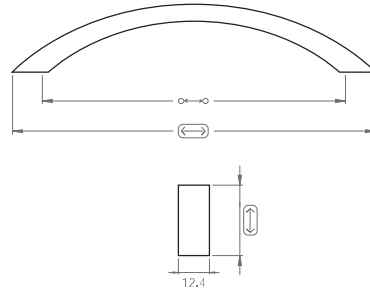

↔	↔	↑	📦
128	150	28	25
192	216	28	25
256	282	28	25

Acabamento: Satinado
Finish: Satin

Asa de Zamak
Zamak Handle

Q34

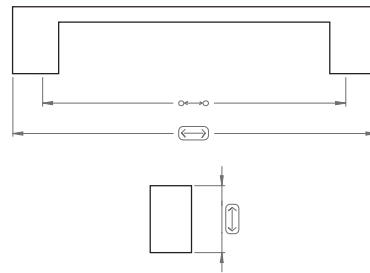

↔	↔	↑	📦
128	144	26	25
160	174	26	25
256	270	26	25

Acabamento: Satinado
Finish: Satin

Asa de Zamak
Zamak Handle

Q35

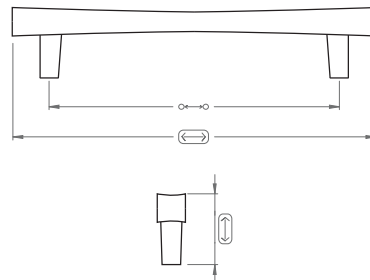

↔	↔	↑	📦
128	168	30	25
160	198	30	25

Acabamento: Satinado
Finish: Satin

Asa de Alumínio
Aluminium Handle

G27

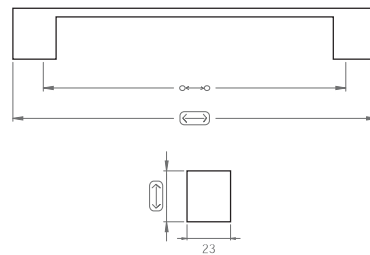

↔	↔	↑	📦
160	192	26	10
192	224	26	10
224	256	28	10

Acabamento: Satinado / Cromado Mate
Finish: Satin / Matte Chrome

Asa de Alumínio
Aluminium Handle

O13

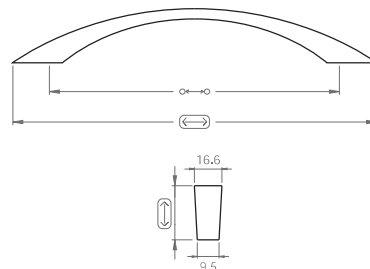

↔	↔	↑	📦
128	160	26	40

Acabamento: Satinado
Finish: Satin

Asa de Alumínio / Zamak
Aluminium / Zamak Handle

K75

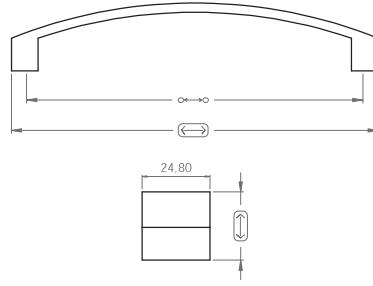

↔	↔	↑	⊞
128	138	24	20
160	170	24	20
192	202	24	20
224	234	34	20
256	266	24	20

Acabamento: Satinado
Finish: Satin

Asa de Alumínio
Aluminium Handle

H16

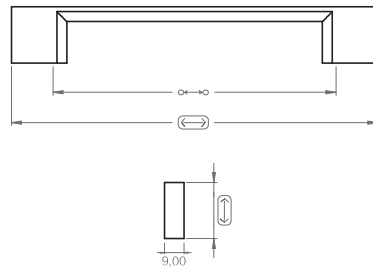

↔	↔	↑	⊞
96	130	26	20
128	162	26	20
160	194	26	20
192	226	28	20
224	258	28	20
256	290	28	20

Acabamento: Satinado / Cromado
Finish: Satin / Chrome

Asa de Alumínio
Aluminium Handle

H15

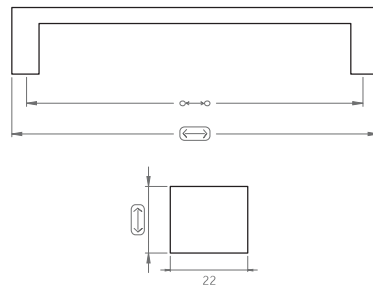

↔	↔	↑	⊞
96	104	24	25
128	136	24	25
160	168	24	25
192	202	24	25
224	234	24	25
320	330	24	25

Acabamento: Satinado
Finish: Satin

Asa de Alumínio
Aluminium Handle

O36

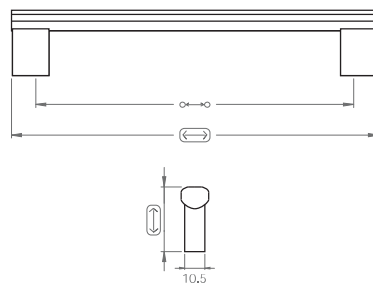

↔	↔	↑	⊞
160	190	34	25
192	222	34	25
224	254	34	25

Acabamento: Satinado
Finish: Satin

Asa de Alumínio
Aluminium Handle

O37

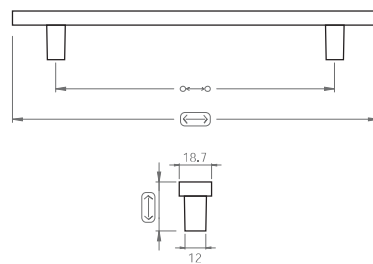

↔	↔	↑	⊞
128	178	28	25
160	202	28	25

Acabamento: Satinado
Finish: Satin

Asa de Alumínio
Aluminium Handle

Q77

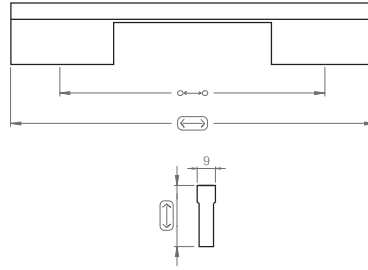

↔	↔	↑	📦
128	176	30	25
160	208	30	25
192	240	30	25
224	272	30	25
256	304	30	25
288	336	30	25
320	368	30	25

Acabamento: Cromado Brilhante
Finish: Bright Chrome

Asa de Zamak
Zamak Handle

R16

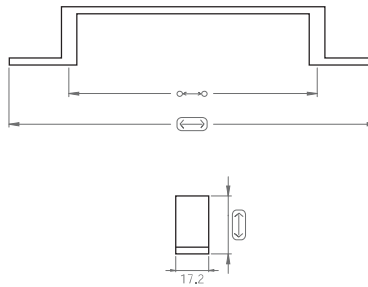

↔	↔	↑	📦
128	190	30	25
160	222	30	25

Acabamento: Satinado
Finish: Satin

Asa de Zamak
Zamak Handle

R17

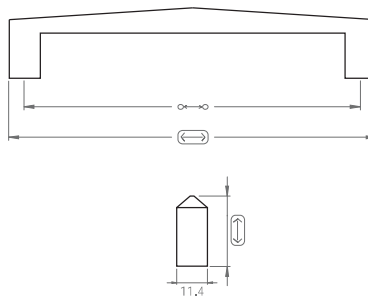

↔	↔	↑	📦
128	136	28	25
160	168	28	25

Acabamento: Satinado
Finish: Satin

Asa de Zamak
Zamak Handle

R18

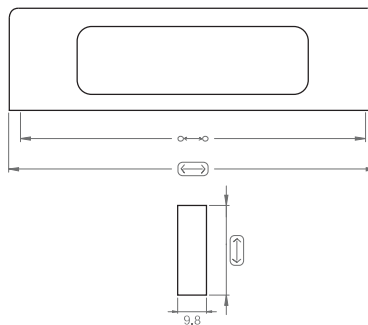

↔	↔	↑	📦
32	44	30	25
96	108	30	25
192	204	30	25

Acabamento: Satinado
Finish: Satin

Asa de Alumínio
Aluminium Handle

R43

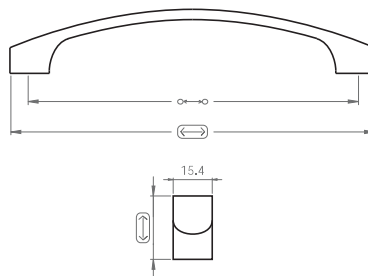

↔	↔	↑	📦
128	148	24	25
160	180	24	25

Acabamento: Satinado
Finish: Satin

Asa de Alumínio
Aluminium Handle

R42

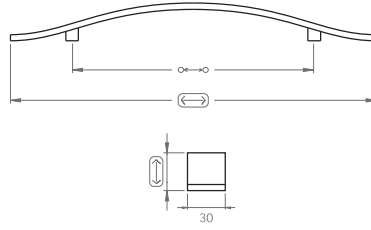

192	290	30	15

Acabamento: Satinado
Finish : Satin

Asa de Alumínio
Aluminium Handle

Q87

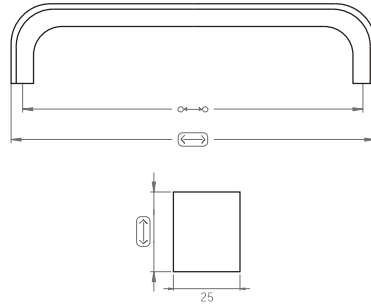

128	136	30	50
160	168	30	50
192	200	30	50
224	232	30	50

Acabamento: Cromado Mate
Finish : Matte Chrome

Asa de Alumínio
Aluminium Handle

Q78

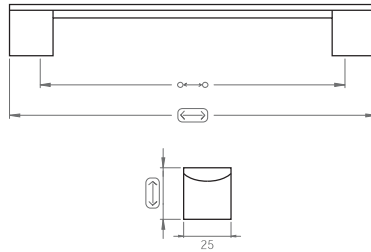

160	192	28	20
192	224	28	20
256	288	28	20
320	352	28	20

Acabamento: Anodizado
Finish : Anodized

Asa de Zamak
Zamak Handle

Q21

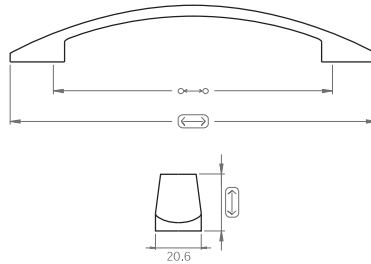

128	166	26	25

Acabamento: Satinado
Finish : Satin

Asa de Zamak
Zamak Handle

G67

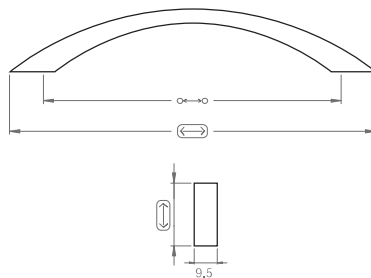

128	150	26	25

Acabamento: Níquel Mate
Finish : Matte Nickel

Asa de Zamak
Zamak Handle

916

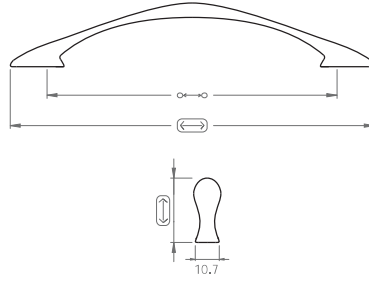

128	158	24	50

Acabamento: Satinado
Finish : Satin

Asa de Zamak
Zamak Handle

906

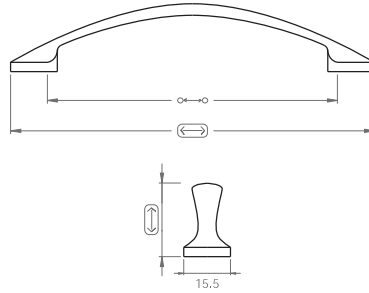

96	170	30	30
128	202	30	30

Acabamento: Níquel Mate
Finish : Matte Nickel

Asa de Zamak
Zamak Handle

907

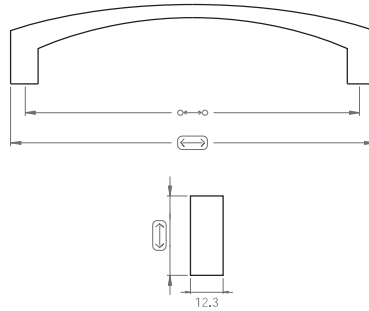

128	134	30	30

Acabamento: Níquel Mate
Finish : Matte Nickel

Asa de Zamak
Zamak Handle

908

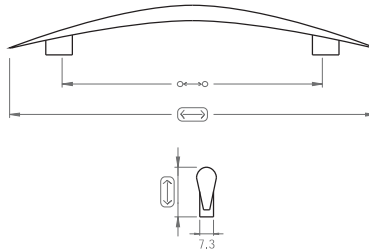

128	184	28	30

Acabamento: Níquel Mate
Finish : Matte Nickel

Asa de Zamak
Zamak Handle

909

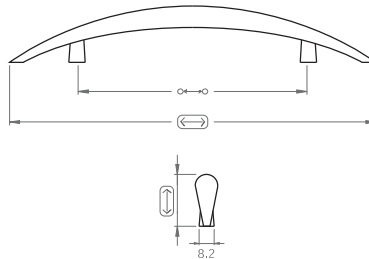

128	202	30	30

Acabamento: Níquel Mate
Finish : Matte Nickel

0

Asa de Zamak
Zamak Handle

919

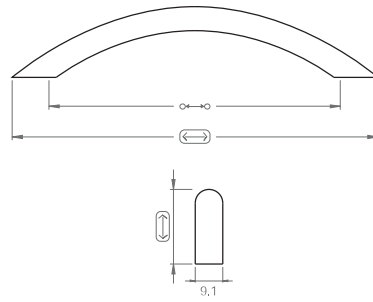

↔	↔	↑	📦
96	120	26	40
128	154	28	30
192	222	28	30

Acabamento: Niquel Mate
Finish: Matte Nickel

Asa de Zamak
Zamak Handle

032

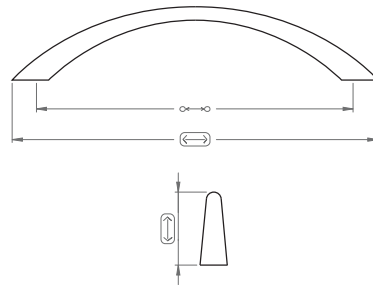

↔	↔	↑	📦
96	112	28	50
128	146	30	25

Acabamento: Niquel Mate / Lat. Oxi.
Finish: Matte Nickel / Oxidized

Asa de Alumínio
Aluminium Handle

M66

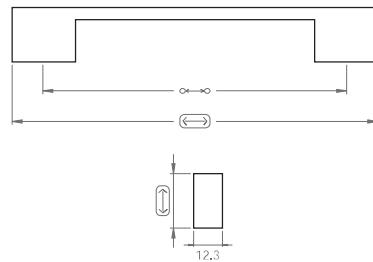

↔	↔	↑	📦
128	152	22	25
160	194	22	25
192	226	22	25
256	280	22	25

Acabamento: Cromado Mate
Finish: Matte Chrome

Asa de Zamak
Zamak Handle

K82

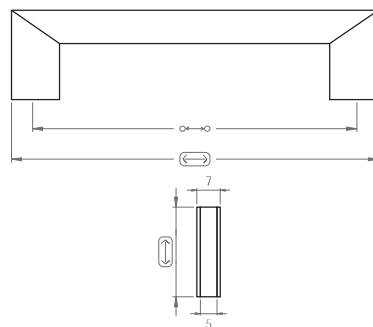

↔	↔	↑	📦
96	108	30	40

Acabamento: Cromado Mate
Finish: Matte Chrome

Asa de Zamak
Zamak Handle

R04

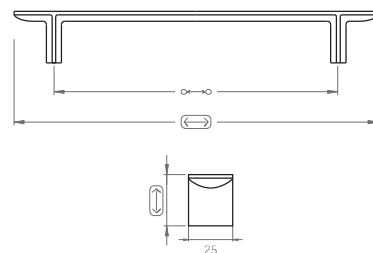

↔	↔	↑	📦
160	204	28	20

Acabamento: Cromado Mate
Finish: Matte Chrome

Asa de Zamak
Zamak Handle

R05

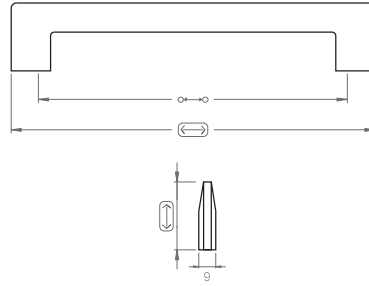

160	186	28	25

Acabamento: Cromado Mate
Finish : Matte Chrome

Asa de Zamak
Zamak Handle

R06

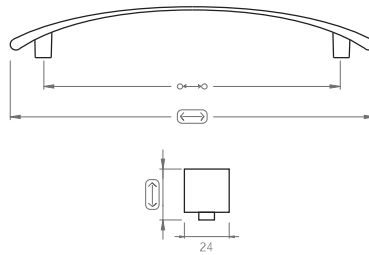

160	196	28	25

Acabamento: Cromado Mate
Finish : Matte Chrome

Asa de Zamak
Zamak Handle

S14

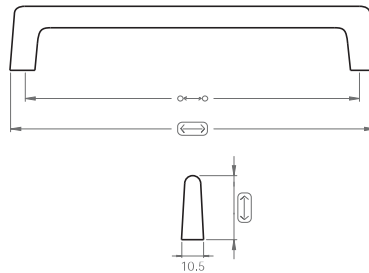

128	140	30	50
160	172	30	40
192	204	30	40

Acabamento: Satinado
Finish : Satin

Asa de Zamak
Zamak Handle

S20

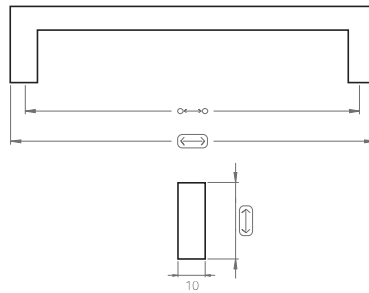

128	138	29	20
160	170	29	20
192	202	29	20

Acabamento: Oxid. Velho / Preto Mate / Cobre Velho
Finish : Old Oxidized / Matte Black / Old Copper

Asa de Zamak
Zamak Handle

M44

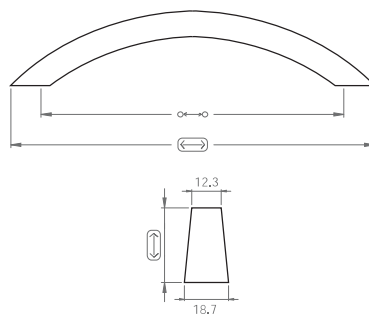

128	152	30	25

Acabamento: Satinado
Finish : Satin

Asa de Zamak
Zamak Handle

K85

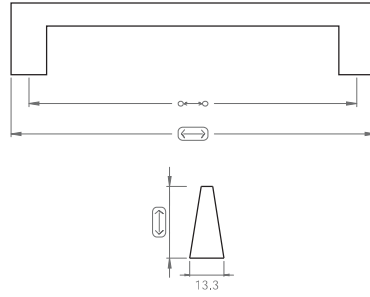

↔	↔	↑	⊞
128	142	28	20
160	174	28	20
224	238	28	20
288	302	28	20

Acabamento: Satinado
Finish: Satin

Asa de Zamak
Zamak Handle

J57

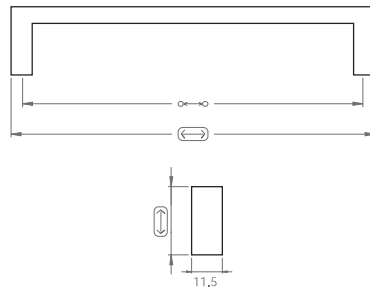
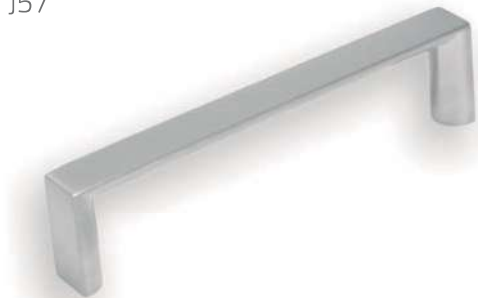

↔	↔	↑	⊞
96	102	24	25
128	134	24	20
160	166	24	20
192	198	24	20
256	262	24	20

Acabamento: Satinado
Finish: Satin

Asa de Zamak
Zamak Handle

O12

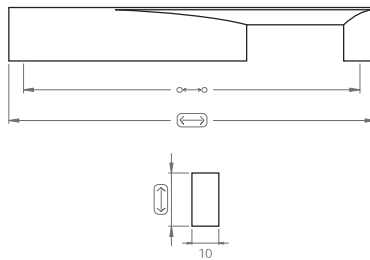

↔	↔	↑	⊞
128	136	20	30
192	200	20	20

Acabamento: Cromado Brilhante
Finish: Bright Chrome

Asa de Zamak
Zamak Handle

N92

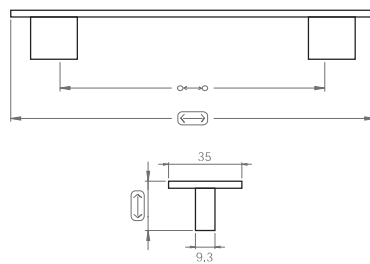

↔	↔	↑	⊞
128	174	24	25

Acabamento: Satinado
Finish: Satin

Asa de Zamak
Zamak Handle

Q07

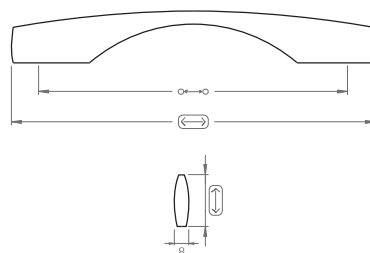

↔	↔	↑	⊞
128	156	28	25
160	188	28	25

Acabamento: Cromado Brilhante
Finish: Bright Chrome

Asa de Zamak
Zamak Handle

Q22

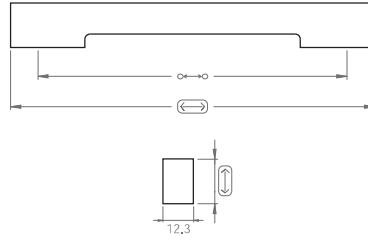

128	146	18	25

Acabamento: Cromado Brilhante / Satinado
Finish: Bright Chrome / Satin

Asas de Aço Inox
Stainless Steel Handles

L95

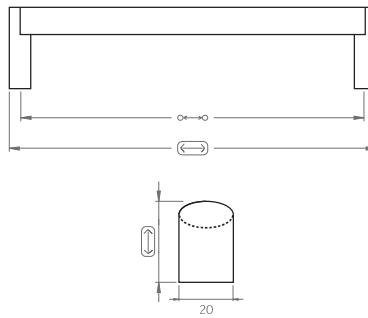

96	102	30	10
128	134	30	10
160	166	30	10
192	198	30	10
224	230	30	10
356	262	30	10
320	326	30	10

Acabamento: Satinado
Finish: Satin

Asas de Aço Inox
Stainless Steel Handles

C55.10

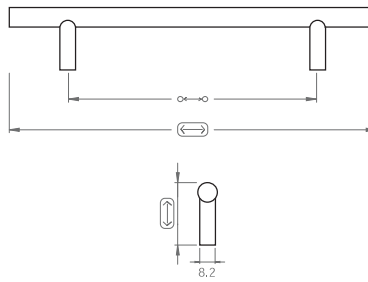

96	156	32	30
128	188	32	30
160	220	32	30
192	252	32	25
224	284	32	25
256	316	32	20
288	348	32	20
320	380	32	20
352	412	32	20
384	444	32	25
416	476	32	25
448	508	32	25
480	540	32	25

Acabamento: Satinado
Finish: Satin

Asas de Aço Inox
Stainless Steel Handles

C55.12

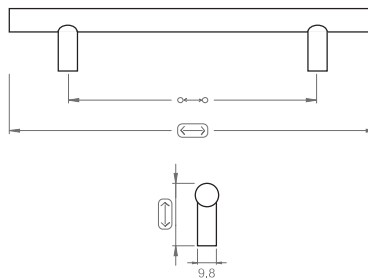

96	156	32	30
128	188	32	30
160	220	32	30
192	252	32	25
224	284	32	25
256	316	32	20
288	348	32	20
320	380	32	20
352	412	32	20
384	444	32	25
448	508	32	20
520	580	32	20
640	700	32	20
736	796	32	20

Acabamento: Satinado
Finish: Satin

Asas de Aço Inox
Stainless Steel Handles

033

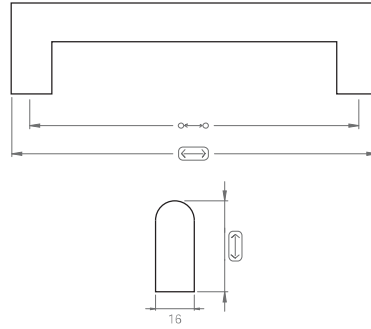

Ø 12
128
192

←→	↔	↑↓	📦
128	142	40	25
160	174	40	25
192	106	40	25
224	238	40	25
256	270	40	25
288	302	40	25
320	334	40	25
448	462	40	25
576	590	40	25
768	782	40	25

Acabamento: Satinado
Finish: Satin

Asas de Aço Inox
Stainless Steel Handles

034

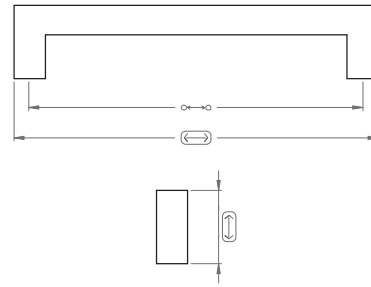

←→	↔	↑↓	📦
96	106	30	25
128	138	30	25
160	170	30	25
192	202	30	25
224	234	30	25
288	298	30	25
320	330	30	25
480	490	30	25
640	650	30	25
736	746	30	25

Acabamento: Satinado
Finish: Satin

Asa de Plástico
Plastic Handle

L85

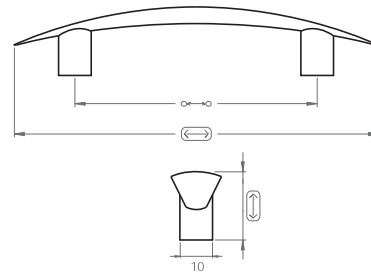

←→	↔	↑↓	📦
96	144	27	50

Acabamento: Transparente
Finish: Transparent

Asa de Zamak
Zamak Handle

Q32

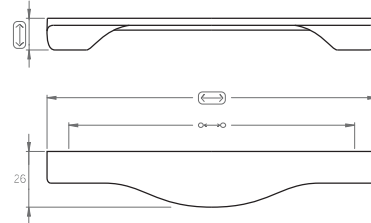

←→	↔	↑↓	📦
128	152	25	25
160	188	25	25
256	294	28	25

Acabamento: Satinado
Finish: Satin

Asa de Zamak
Zamak Handle

584

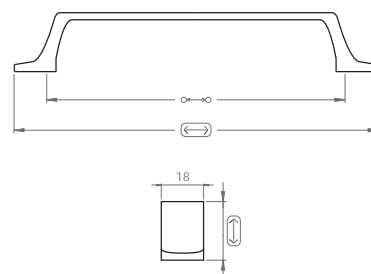

←→	↔	↑↓	📦
128	156	25	25
192	220	25	25

Acabamento: Satinado
Finish: Satin

0

Asa de Alumínio
Aluminium Handle

M88

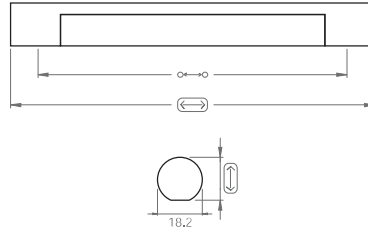

64	84	20	25
96	116	20	25
128	148	20	25

Acabamento: Anodizado Mate
Finish: Matte Anodized

Asa de Alumínio
Aluminium Handle

H97

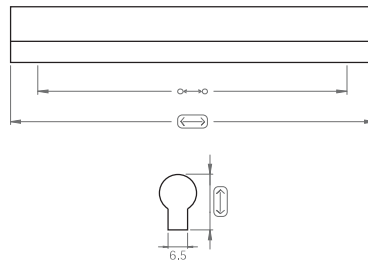

64	90	18	50
96	120	18	50
128	150	18	25

Acabamento: Anodizado Mate
Finish: Matte Anodized

Asa de Alumínio
Aluminium Handle

F41

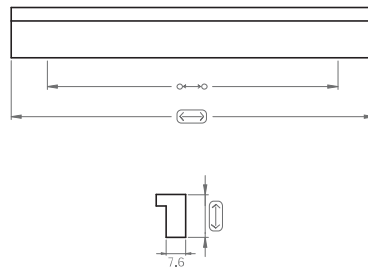

1F	12	17	250
64	80	17	250
96	120	17	250
128	150	17	250
160	200	17	250

Acabamento: Anodizado Mate
Finish: Matte Anodized

Asa de Alumínio
Aluminium Handle

J53

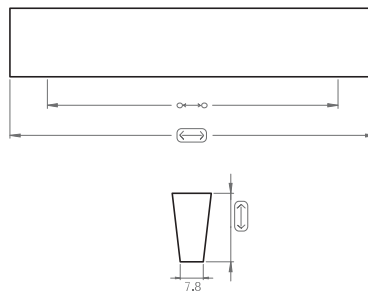
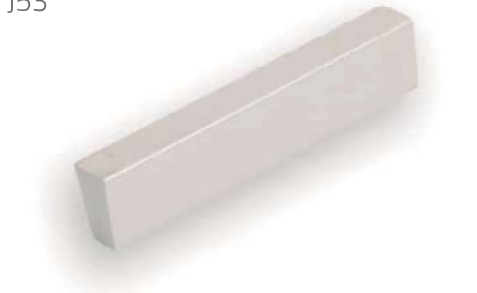

32	48	18	250
64	80	18	250
96	112	18	250

Acabamento: Anodizado Mate
Finish: Matte Anodized

Asa de Alumínio
Aluminium Handle

J85

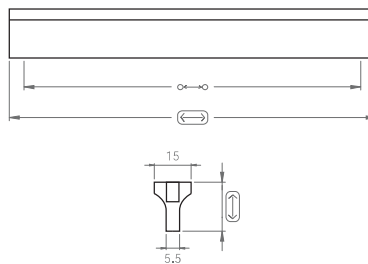

64	80	20	250
96	120	20	250
128	150	20	250

Acabamento: Anodizado Mate c/ Wengue / Cerejeira
Finish: Matte Anodized w/ Wengue / Cherry

Asa de Alumínio
Aluminium Handle

A17

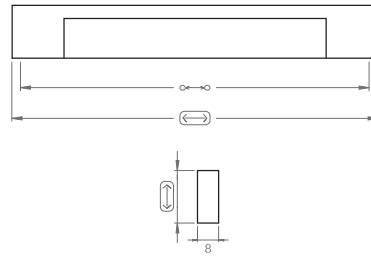

128	138	20	50
192	200	20	25

Acabamento: Cromado Brilhante
Finish : Bright Chrome

Asa de Alumínio
Aluminium Handle

M57

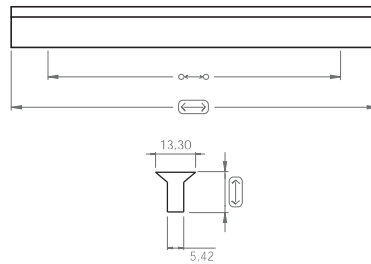

32	45	14	30
64	90	14	100
96	120	14	50
128	150	14	50
160	198	14	50
192	248	14	25

Acabamento: Anodizado Mate / Cromado Brilhante
Finish : Matte Anodized / Bright Chrome

Asa de Alumínio
Aluminium Handle

J50

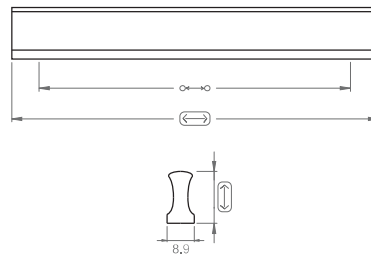

96	120	18	125
128	150	18	125
160	160	18	125

Acabamento: Anodizado Mate / Cromado Brilhante *
Finish : Matte Anodized / Bright Chrome *

Asa de Alumínio
Aluminium Handle

Q20

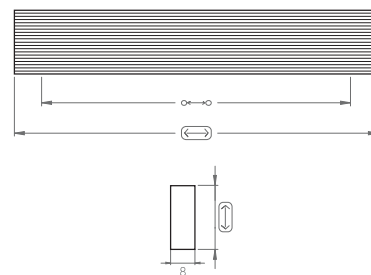

96	118	20	50

Acabamento: Cromado Brilhante
Finish : Bright Chrome

Asa de Zamak
Zamak Handle

Q05

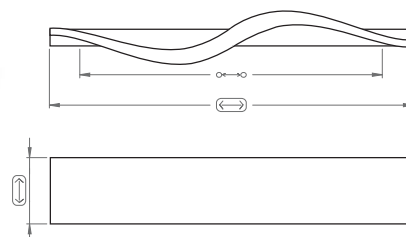

128	166	30	25

Acabamento: Cromado Brilhante
Finish : Bright Chrome

Asa de Alumínio
Aluminium Handle

L82

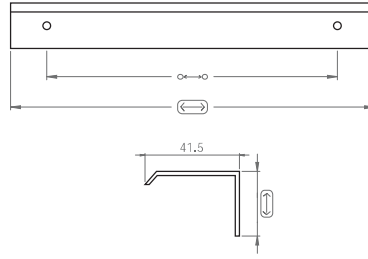

Ø	Length	Height	Box Qty
32	45	36	100
160	200	36	50
160	300	36	50
-	3000	36	50

Acabamento: Cromado Brilhante / Anodizado Mate
Finish : Bright Chrome / Matte Anodized

Asa de Alumínio
Aluminium Handle

O38

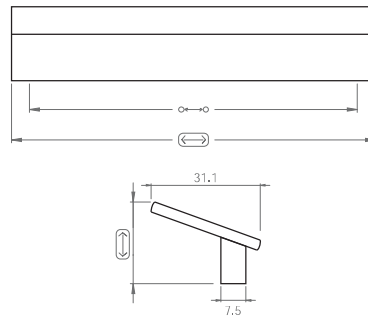

Ø	Length	Height	Box Qty
96	114	16	25
128	146	16	25
160	178	16	25
192	210	16	25
224	242	16	25

Acabamento: Satinado
Finish : Satin

Asa de Alumínio
Aluminium Handle

S02

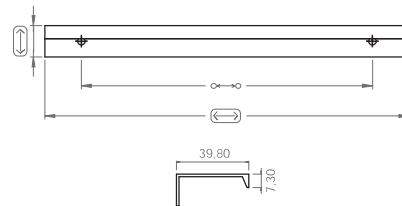
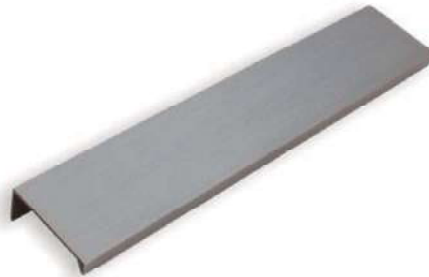

Ø	Length	Height	Box Qty
160	200	18	100
-	3000	18	100

Acabamento: Satinado Champanha
Finish : Champagne Satin

Asa de Zamak
Zamak Handle

R07

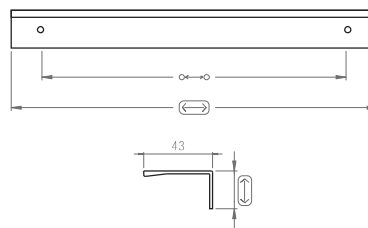

Ø	Length	Height	Box Qty
192	230	42	20

Acabamento: Cromado Mate
Finish : Matte Chrome

Asa de Zamak
Zamak Handle

C81

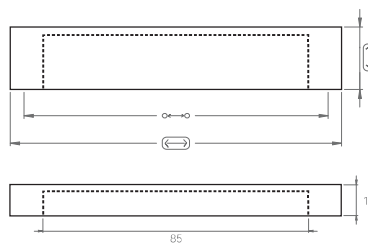

Ø	Length	Height	Box Qty
64	72	20	40
96	104	20	40

Acabamento: Níquel Mate
Finish : Matte Nickel

Asa de Zamak
Zamak Handle

K52

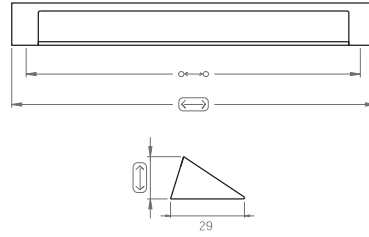

64	74	16	40
96	106	16	40
128	138	16	40

Acabamento: Satinado
Finish : Satin

Asa de Zamak
Zamak Handle

K81

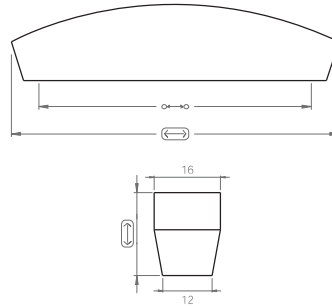

64	78	20	40

Acabamento: Cromado Mate
Finish : Matte Chrome

Asa de Alumínio
Aluminium Handle

N47

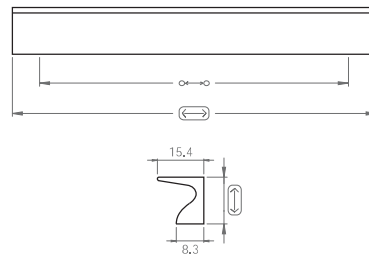

64	90	16	50
96	120	16	50
128	150	16	40

Acabamento: Anodizado
Finish : Anodized

Asa de Zamak
Zamak Handle

814

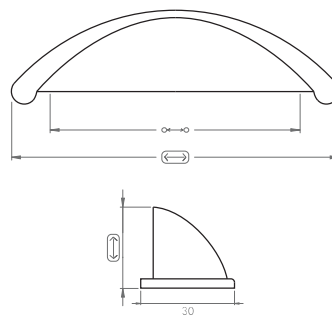

64	104	26	25

Acabamento: Satinado / Oxid, Francés
Finish : Satin / Oxidized

Asa de Zamak
Zamak Handle

F18

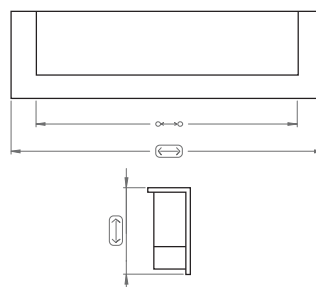

96	106	29	30
128	139	29	30

Acabamento: Niquel Mate
Finish : Matte Nickel

Asa de Zamak c/ Terminais Cromado
Zamak Handle w/ Chrome Terminals

J75

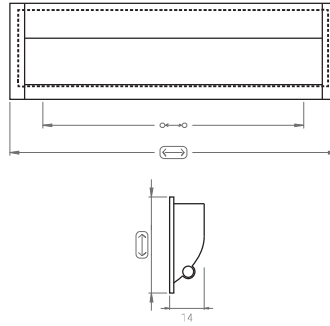

96	126 x 32	122	14	100
128	148 x 32	154	14	100
160	190 x 32	198	14	100
192	212 x 32	218	14	100

Acabamento: Anodizado Mate
Finish : Matte Anodized

Asa de Zamak
Zamak Handle

J10

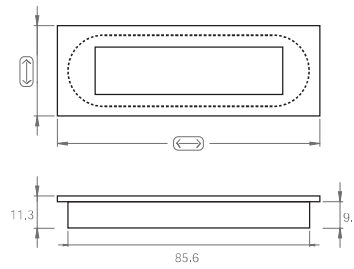

76	85 x 25	92	32	20
128	134 x 28,5	138	39	20

Acabamento: Níquel Mate / Cromado Mate
Finish : Matte Nickel / Matte Chrome

Asa de Zamak
Zamak Handle

L99

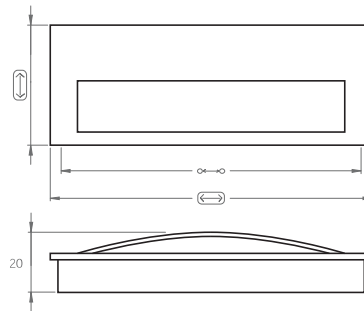

96	106	40	25

Acabamento: Satinado
Finish : Satin

Asa de Zamak
Zamak Handle

J02

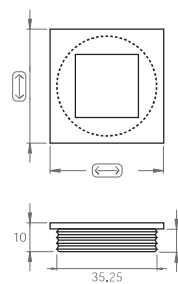

35 Ø	40	40	50

Acabamento: Níquel Mate
Finish : Matte Nickel

Puxador de Aço Inox
Stainless Steel Handle

L84

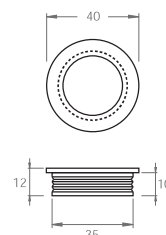

35 Ø	40	40	75

Acabamento: Satinado
Finish : Satin

Puxador de Plástico
Plastic Knob

717

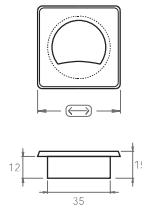

35 Ø	45	45	1000

Acabamento: Níquel Mate
Finish : Matte Nickel

Puxador de Zamak
Zamak Knob

K53

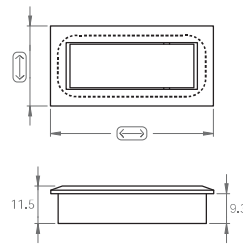

45 x 18	50	24	50

Acabamento: Satinado
Finish : Satin

Puxador de Zamak
Zamak Knob

F32

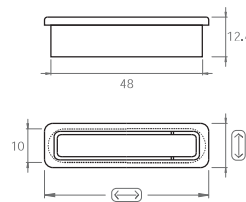

48 x 10	50	14	60

Acabamento: Níquel Mate
Finish : Matte Nickel

Asa de Zamak
Zamak Handle

H02

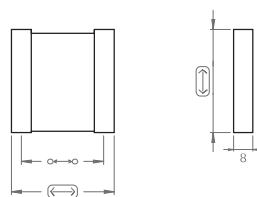

32	40	8	50

Acabamento: Níquel Mate
Finish : Matte Nickel

Puxador c/Movimento
Knob w/Movement

M52

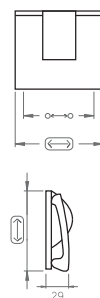

32	42	37	50

Acabamento: Satinado
Finish : Satin

0

Puxador c/Movimento
Knob w/Movement

L91

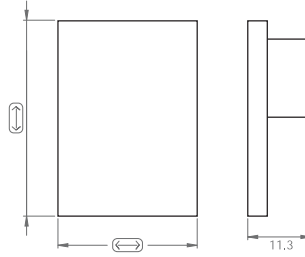

-	25	35,5	50

Acabamento: Satinado / Mate
Finish : Satin / Matte

Puxador c/Couro Castanho
Knob w/Brown Leather

M53

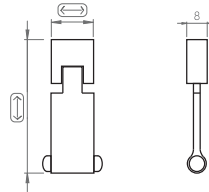

16,3	50	50

Acabamento: Cromado Mate
Finish : Matte Chrome

Asa de Zamak
Zamak Handle

N92.32

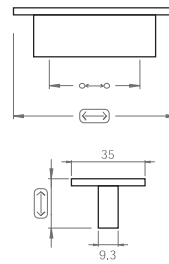

32	76	24	25

Acabamento: Satinado
Finish : Satin

Puxador de Zamak
Zamak Knob

O39

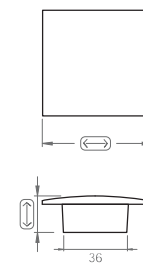

-	58	18	25

Acabamento: Satinado
Finish : Satin

Puxador de Zamak
Zamak Knob

N30

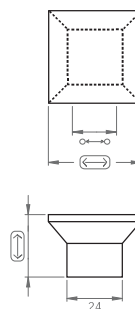

16	40	26	25

Acabamento: Satinado
Finish : Satin

0

Puxador de Zamak
Zamak Knob

R16.00

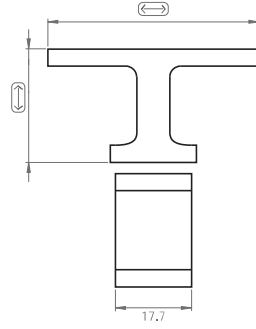

49	25.7	25

Acabamento: Satinado
Finish : Satin

Puxador de Zamak
Zamak Knob

R17.00

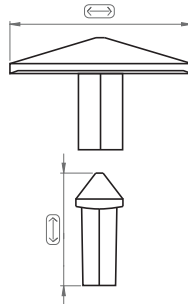

28.5	46	25

Acabamento: Satinado
Finish : Satin

Puxador de Alumínio
Aluminium Knob

R54

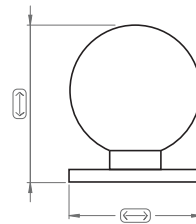

20	25	100
25	30	50

Acabamento: Satinado
Finish : Satin

Puxador de Zamak
Zamak Knob

H95

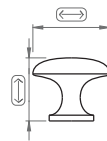

30	24	25

Acabamento: Níquel Mate / Oxid. Françês
Finish : Matte Nickel / Oxidized

Puxador de Zamak
Zamak Knob

H96

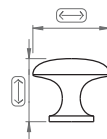

25.5	23.5	50

Acabamento: Níquel Mate / Oxid. Françês
Finish : Matte Nickel / Oxidized

Puxador de Zamak
Zamak Knob

K80

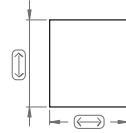

16	18	125
20	24	80

Acabamento: Satinado
Finish : Satin

Puxador de Zamak
Zamak Knob

F34

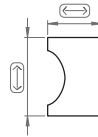

18	21	100

Acabamento: Sat./Crom. Mate/Niq. Mate
Finish : Satin/Matte Chrome/Matte Nickel

Puxador de Zamak
Zamak Knob

F33

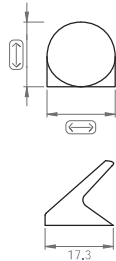

22	20	50

Acabamento: Niquel Mate
Finish : Matte Nickel

Puxador de Zamak
Zamak Knob

G75

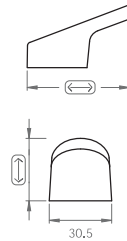

44	30	50

Acabamento: Niquel Mate
Finish : Matte Nickel

Puxador de Zamak
Zamak Knob

N59

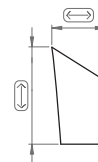

14	25,4	50

Acabamento: Niquel Mate
Finish : Matte Nickel

Puxador de Zamak
Zamak Knob

G66

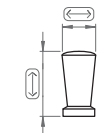

10	15	50

Acabamento: Niquel Mate
Finish : Matte Nickel

Puxador Zamak
Zamak Knob

G76

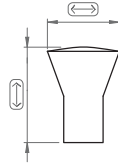

15,4	21	50

Acabamento: Nickel Mate
Finish : Matte Nickel

Puxador Zamak
Zamak Knob

K76

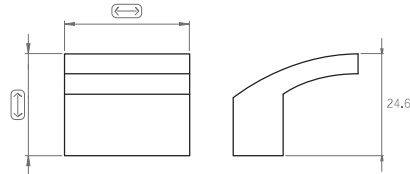

25	20,5	50

Acabamento: Satinado
Finish : Satin

Puxador Zamak
Zamak Knob

923

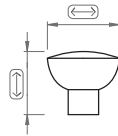

28	28	50

Acabamento: Satinado
Finish : Satin

Puxador de Inox
Stainless Steel Knob

503

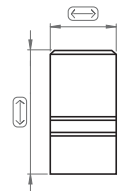

12,5	24	50

Acabamento: Satinado
Finish : Satin

Puxador de Porcelana
Porcelain Knob

374

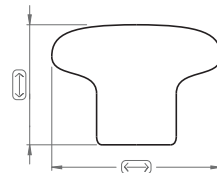

32	24,5	50
38	27	50

Acabamento: Branco
Finish : White

Puxador de Borracha
Rubber Knob

P51

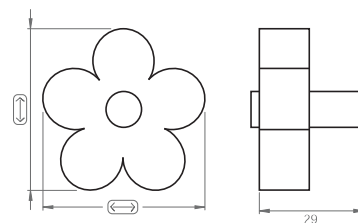

48	46	50

Acabamento: Rosa
Finish : Rose

0



P

Diversos
Others



Deslizador de Feltro
Felt Slipper

005

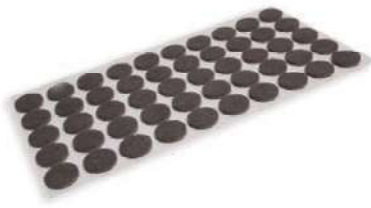

3	22	1000

Tapafuros
Masket for Holes

529

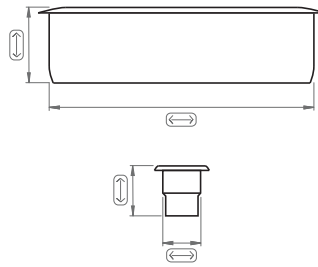

10	35	100

Cores Colors	
Branco White	Castanho Brown

6	5	10000

Cinza Grey	Branco White
Preto Black	Castanho Brown
Pinho Pine	Cinza Escuro Dark Gray

Tapafuros Autocolante
Self Adhesive Screw Cover

D49

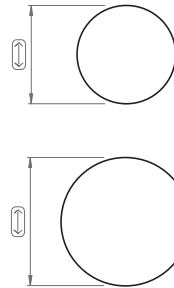

13

Cores Colors			
Branco White	Nogueira Walnut	Pinho Pine	Faixa Beech
Preto Black	Sapelly Sapelly	Cerejeira Cherry	Maple Maple
Crom. Mate Matte Chrome	Linho Claro Light Flax	Creme Cream	Wengue Wengue
Carv. Claro Light Oak	Carvalho Oak	Faixa Vap. Vap. Beech	Cinza Grey

17

Cinza Grey	Wengue Wengue	Faixa Beech	Branco White
Creme Cream	Sapelly Sapelly	Preto Black	Maple Maple
Nogueira Walnut			

Cordão p/Fixar Portas Vidro
Glass Door Fixation Rope

566



6	1000

Cores Colors	
Carvalho Oak	Branco White
Preto Black	Castanho Brown
Bege Beige	

Batente Mórvido
Morbid Stop

063

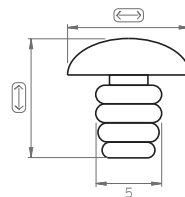

20	10	10000

Cores Colors	
Branco White	Transparente Transparent

Batente Autocolante
Self Adhesive Stop

C97

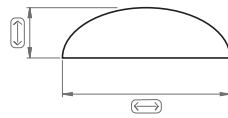

3	10	5000

Batente Autocolante
Self Adhesive Stop

062

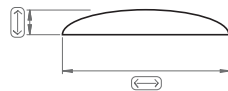

1,5	10	5000

Passa Cabos Plástico
Plastic Cable Duct

M67



22	60	100

Cores Colors	
Cinza Grey	Branco White
Preto Black	Castanho Brown
Creme Cream	Carvalho Oak

Passa Cabos Zarnak Satinado
Satin Zarnak Cable Duct

R23



16	60	80
18	80	80

Disco de Lixa
Sandpaper Disc

715

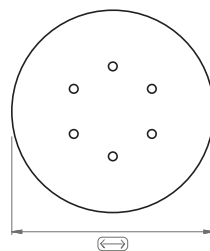

120	150	250
150	150	250
180	150	250
220	150	250
280	150	250

Esponja de Lixa
Sandpaper Sponge

14

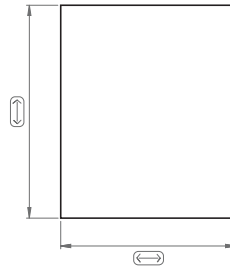

Sup. Fino	140	115	1000
Fino	140	115	1000
Médio	140	115	1000

Folha de Lixa
Sandpaper Sheet

143

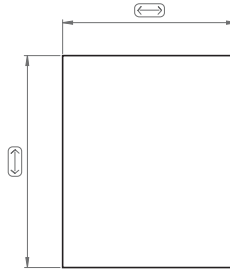

320	280	230	100

Taco de Lixa
Sandpaper Taco

41

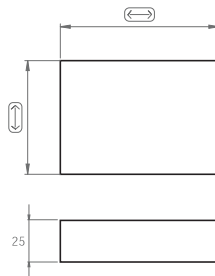

100	68	95	50
180	68	95	50

Rolo de Lixa
Sandpaper Roll

311

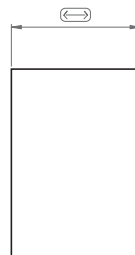

50000	115	1

Fita Dupla Face p/Espelhos
Mirror Double Face Tape

200



50000	19	25
50000	25	25

Fita-Cola
Tape

201

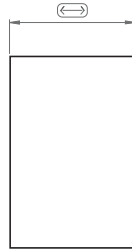

66000	38	25
66000	50	25

Filme Transparente
Transparent Film

N09



49	6

Tela de Alumínio Auto-Colante
Self-Adhesive Aluminium Foil

055

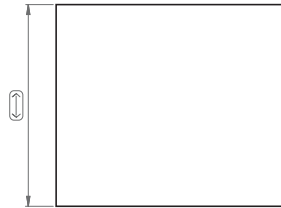

1000	40	1

Betume de Cera
Bitumen Bar

324

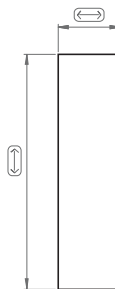

9,5	2,5	10

Cores Colors	
Carvalho Oak	Branco White
Preto Black	Cinza Grey
Mogno Mahogany	Faixa Vap. Vap. Beech
Castanho Brown	

Bisnaga de Betume
Bitumen Tube

057



25

Cores Colors		
Branco White	Nogueira Walnut	Pinho Pine
Preto Black	Sapelly Sapelly	Cerejeira Cherry
Faixa Beech	Carvalho Oak	Urucumano Urucumano
Faixa Vap. Vap. Beech		

Bisnaga de Betume
Bitumen Tube

R62



Cores Colors	
Branco White	Faixa Beech
Pinho Pine	Cast. Claro Light Brown
Mogno Mahogany	Wengue Wengue

Caneta Corretora
Broker Pen

R61

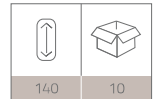
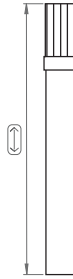

Cores Colors		
Cast. Claro Light Brown	Mogno Mahogany	Pinho Pine
Preto Black	Castanho Brown	Cerejeira Cherry
Faixa Beech	Douglas Douglas	Wengue Wengue

Caneta Corretora
Broker Pen

R69

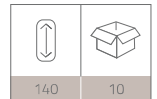
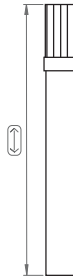

Cores Colors	
Branco White	Cinza Claro Light Gray
Cinza Grey	Cinza Esc. Dark Gray

Puxador de Porta Interior
Interior Door Handle

P06

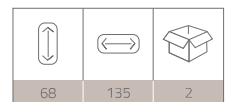
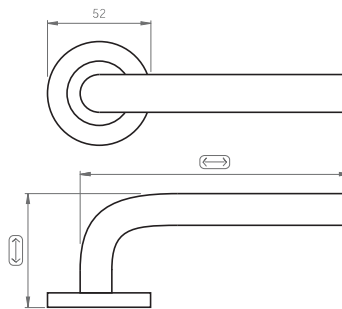

Puxador de Porta Interior
Interior Door Handle

P09

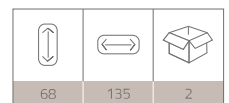
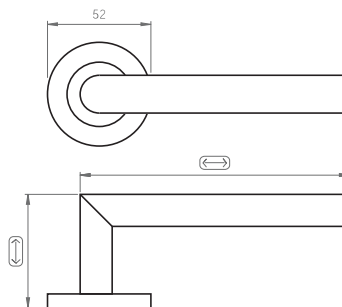

Base de TV
TV Base

C23

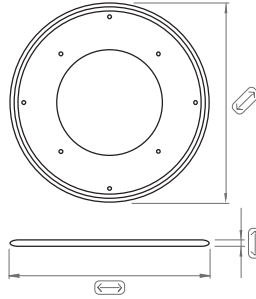

10	305	305

Base de TV
TV Base

714.15

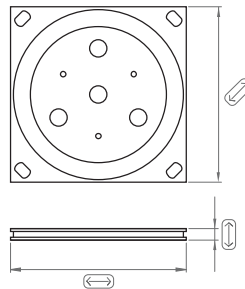

10	150	150

Base de TV
TV Base

714.26

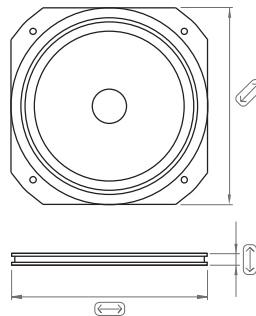

10	260	260

Anilha Salvaespelho
Nylon Bush

683

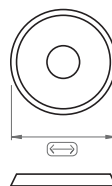

13,9	1000

Anilha Plástica Transparente
Transparent Plastic Ring

682

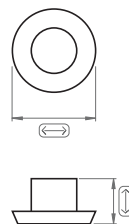

5	11	1000

Pontas Pozidrive
Pozidrive Tips

K43

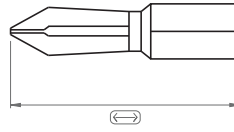

PZ	↔	📦
1	25	10
2	25	10

Ventosa para Vidro
Suction Cup for Glass

541

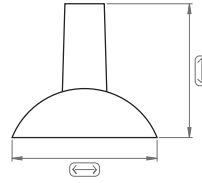

↑	↔	📦
17.7	20	1000

Perfil para Vidros
Glass Profile

278

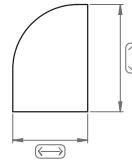

↑	↔
9	6,4

Cores Colors	
Branco White	Castanho Brown
Preto Black	Creme Cream

Vertebra p/ Passar Cabos
Cable Duct Vertebra

C29

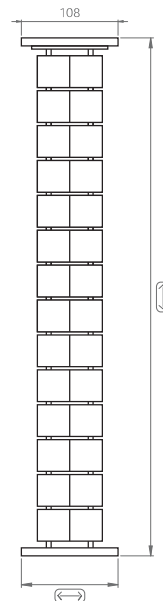

↑	↔	📦
770	131	1



FBL - Acessórios para Móveis, Lda
Av. D. Dinis, 17 - Ferraria
Pataias
2445-076 Pataias
Portugal

Tel. [+351] 244 587 220
Fax [+351] 244 587 222

E-mail: geral@fbl-fabulis.com
export@fbl-fabulis.com

www.fbl-fabulis.com